

HOME VENTILATION WITH HEAT RECOVERY

M-WRG-K ventilation unit (comfort version)

**M-WRG-K
M-WRG-K/FC**



OPERATING INSTRUCTIONS

Part no. 5302-01-01 Week 08/2016 EN



Contents

1	Introduction	5
1.1	Notes on the operating instructions	5
1.2	Description	5
1.3	Target group	6
1.4	EC Declaration of Conformity	6
1.5	National technical approval (for Germany)	6
1.6	Nameplate	7
1.7	Technical data	7
1.7.1	Electrical connection	7
1.7.2	Dimensions and weight	7
1.7.3	Noise emission	7
1.7.4	Unit properties	7
1.7.5	Unit features	7
1.7.6	Filters	8
1.8	Storage	8
1.9	Environmentally-friendly disposal	8
1.10	Revision index	8
1.11	Explanation of the symbols used	8
2	Safety instructions	9
2.1	Hazard classification	9
2.2	Notes on using the ventilation units safely	9
2.3	Notes on using the ventilation units	10
2.4	Intended use	10
3	Warranty and liability	11
3.1	Warranty	11
3.2	Liability	11
4	Dimensions	11
5	Structure and functions	12
5.1	Overview of the modules	12
5.1.1	Ventilation unit – cover attached	12
5.1.2	Ventilation unit – cover removed	12
5.1.3	Outer wall terminal	12
5.2	Description of the functions	13
5.2.1	How the M-WRG ventilation unit works	13
5.2.2	How the cross-flow plate heat exchanger works	14
6	Rules for correct usage	14
6.1	General	14
6.2	Operation in high atmospheric humidity	14
6.3	Operation at cold times of year	15
6.4	Filters	15
7	Controls and displays	16
7.1	Controls and displays on the ventilation unit	16
7.2	LCD display	16
7.3	Infrared remote control	17

8	Starting up	18
8.1	Check ventilation unit before switching on for first time	18
8.2	Switch on the ventilation unit	18
8.3	Check position of air flaps	18
8.4	Insert batteries in infrared remote control	19
9	Operating the ventilation unit	20
9.1	Operation without infrared remote control – "P0" Stepping switch mode	20
9.2	Operation with infrared remote control	20
9.2.1	Change program	20
9.2.2	Save / discard settings	20
9.3	Set day and time	21
10	Ventilation programs	22
10.1	"P0" Stepping switch mode	22
10.2	"P1" Continuous operation	22
10.3	"P2" Interval program	23
10.4	"P3" Day/week program	24
10.5	"P4" Humidity program	25
10.6	"P5" Temperature program	27
10.7	"P6" Air quality	28
10.8	"P7" Ventilation program (cross-ventilation with two ventilation units)	30
11	Additional functions	33
11.1	Set ventilation unit to Standby mode	33
11.2	Set language	33
11.3	"P8" Settings	34
11.3.1	Set day and time	34
11.3.2	Frost protection function	34
11.3.3	Close flaps in pause mode	35
11.4	"P9" Operating hours	36
12	Filter maintenance	37
12.1	Choice of filter	37
12.2	Ordering filters	37
12.3	Filter change	37
12.3.1	Remove cover from ventilation unit	38
12.3.2	Remove filter	38
12.3.3	Insert new filters	38
12.3.4	Attach cover to ventilation unit	39
13	Cleaning	40
14	Troubleshooting	41
15	Overview of the programs	42



1 Introduction

1.1 Notes on the operating instructions

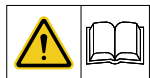

These original operating instructions contain important information that should be followed when setting up and using the M-WRG-K ventilation unit.

- ▶ Read all the instructions carefully before starting up the ventilation unit to avoid possible risks and mistakes.
- ▶ When assembly is complete, give these instructions to the home owner, caretaker or property manager.
- ▶ These instructions are part of the product. Keep the instructions in a safe place for future reference.

WARNING

- ▶ Follow ALL danger and warning instructions and notes on precautionary measures.
- ▶ Read section „2 Safety instructions“ on page 9 carefully.

1.2 Description

These instructions describe how to set up and operate the decentralised ventilation units M-WRG-K and M-WRG-K/FC (see Fig. 1).



Fig. 1: M-WRG-K and M-WRG-K/FC ventilation units

M-WRG-K stands for Meltem heat recovery with comfort. Home ventilation expertise extending back over 30 years has been incorporated into this product from Meltem Wärmerückgewinnung. Using windows for ventilation, particularly during periods of cold weather, is now a thing of the past.

This ventilation unit brings in outdoor air fully automatically, and heats it by recovering heat from the air that is extracted. Outdoor air and extract air are routed in separate ducts through a cross-flow plate heat exchanger (see section 5.2.2 on page 14). You save on heating costs, increase your living comfort and are kind to the environment by reducing CO₂ emissions. A filter also removes pollen, dust and other impurities from the outdoor air.

The ventilation units are designed for continuous operation and can be both surface-mounted and flush-mounted. The ventilation units are low-maintenance, but **regular filter changes** are important.

The M-WRG-K ventilation unit has various ventilation programs, including humidity control. The M-WRG-K/FC also has a CO₂ and mixed gas control. Mixed gases are volatile organic compounds (VOCs) and are the second important measurement, after the CO₂ content, for assessing the air quality. An integrated microprocessor calculates the optimum air renewal from the values measured by the atmospheric humidity, CO₂ and mixed gas sensors and sets the correct ventilation level fully automatically.

The infrared remote control M-WRG-FB is needed to program the ventilation units.

1.3 Target group

These operating instructions are intended for users of the ventilation unit. They do not require any special prior knowledge.

1.4 EC Declaration of Conformity

The ventilation units (comfort version) described below

Type:	M-WRG-K	M-WRG-K/FC
Part number:	5030	5030-2

manufactured by

Meltem Wärmerückgewinnung GmbH & Co. KG
Am Hartholz 4
82239 Alling

conform to the regulations and standards listed in the EC Declaration of Conformity provided.

1.5 National technical approval (for Germany)

A valid national technical approval from the Deutsches Institut für Bautechnik (DIBt) must be obtained for the ventilation unit before it is installed in Germany. This approval can be provided upon request or can be downloaded from our website at www.meltem.com/waermerueckgewinnung/downloads/ (see also the QR code on the back page of these instructions).

The approval number is Z-51.3-138 (see item 1 in Fig. 2).

- For installation outside Germany, the national regulations applicable in your country should be followed.

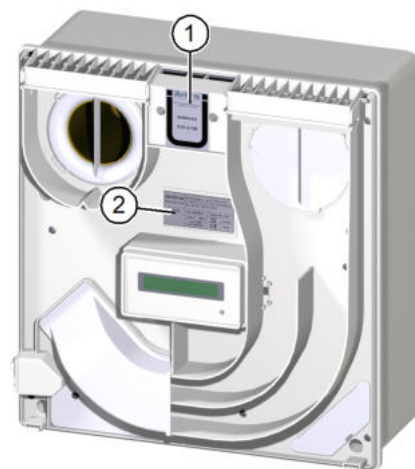

Fig. 2: Approval number and nameplate

1.6 Nameplate

You will find the nameplate on the intermediate plate on the inside of the housing (see item 2 in Fig. 2 on page 6).

1.7 Technical data

1.7.1 Electrical connection

Operating voltage	230 VAC
Mains frequency	50 Hz
Power consumption	3.8 - 34 W
Power consumption in relation to the air volume flow	0.17 W/m ³ /h (at 30 m ³ /h)
Maximum current consumption	0.16 A
Connecting cable	NYM-J 3 x 1.5 mm ²
IP rating	IPX1 IPX4 with protective cap on mains switch (optional, must be installed at the factory)

1.7.2 Dimensions and weight

Unit dimensions excluding air connectors (see also Fig. 3 on page 11)	409 mm x 388 mm x 196 mm (H x W x D)
Visible unit depth when surface-mounted	196 mm
Visible unit depth when flush-mounted	66 mm
Outdoor air/exhaust air connectors	DN 100
Weight	approx. 8.1 kg

1.7.3 Noise emission

Sound pressure level $L_{p,A}$ flush-mount	15.5 - 46.5 dB(A)/ A_{eq} 10 m ²
Sound pressure level $L_{p,A}$ surface-mount	19 - 46 dB(A)/ A_{eq} 10 m ²
Sound insulation $D_{n,e,w}$ flush-mount/surface-mount	50/50 dB

1.7.4 Unit properties

Air flow	15 - 100 m ³ /h
Heat recovery efficiency	up to 76 %
Leakage	0.1 %

1.7.5 Unit features

Output control	10 levels
Supply air/extract air fan	EC direct current motor, radial fan

Heat exchanger	Cross-flow plate heat exchanger
Filter change indicator (depends on the level of soiling of the filter)	Visual and audible
Condensate drainage	Via exhaust air pipe, no condensate trap required
Fully automatic cover flap control when switching On / Off, in Standby mode and if the power fails	yes
Frost protection function	yes
Humidity control	yes
Temperature control	yes
CO ₂ and mixed gas control	M-WRG-K/FC only
Various ventilation programs (time, temperature, supply/extract air)	yes
LCD display	yes
Infrared remote control M-WRG-FB	Also required to operate the M-WRG-K, not supplied as standard

1.7.6 Filters

Designation	Filter class	Filter area
Standard filter	G4	0.36 m ²
Allergy filter (optional)	F7	0.32 m ²
Activated charcoal filter (optional)	M6	0.12 m ²

1.8 Storage

- ▶ Store the ventilation unit in its original packaging in a dry place where the temperature ranges between 0 °C and +40 °C.

1.9 Environmentally-friendly disposal

The ventilation units must not be disposed of in the residual waste bin.



- ▶ Dispose of the ventilation unit in accordance with the electronic waste disposal regulations that apply on site.

1.10 Revision index

Edition	Manual	Date
4 th edition	Operating instructions for the M-WRG-K ventilation unit (comfort version)	Week 08/2016 EN

1.11 Explanation of the symbols used

- ▶ This symbol indicates an action to be taken.
- This symbol indicates a list.

2 Safety instructions

This manual contains notes that you must follow for your own personal safety and to avoid injury and damage to property. They are highlighted by warning triangles and are shown as follows according to the level of danger.

2.1 Hazard classification

DANGER

The signal word designates a hazard with a **high** degree of risk which, if it is not avoided, will result in death or severe injury.

WARNING

The signal word designates a hazard with a **medium** degree of risk which, if it is not avoided, will result in death or severe injury.

CAUTION

The signal word designates a hazard with a **low** degree of risk which, if it is not avoided, could result in minor or moderate injury.

NOTE

A note as used in this manual contains important information about the product or about a part of the manual to which particular attention should be paid.

2.2 Notes on using the ventilation units safely

WARNING

— **Fire protection**

- ▶ Follow the requirements of the national technical approval from the Deutsches Institut für Bautechnik (DIBt), approval number Z-51.3-138, when planning and installing the unit.

— **Operation with fireplaces**

- ▶ An additional safety device (underpressure or differential pressure monitor) is needed to monitor operation when M-WRG ventilation units are used in conjunction with fireplaces.
- ▶ Follow the requirements of the German Fire Code (FeuVo) when planning and installing the unit.
- ▶ Contact the local chimney sweep before the end of the planning phase.
- ▶ Have the chimney sweep approve the operation of the ventilation unit.

— **Installation in wet areas**

The following rules from DIN VDE 0100-701/702 apply to installation in wet areas:

- Protection zone 0 and 1: The unit must NOT be installed in these areas.
- Protection zone 2: The unit may be installed in this area if the mains switch is covered with a protective cap. The protective cap must be installed at the factory.
 - ▶ You will need to include the mains switch protective cap (M-WRG-SN,

part no. 5430) when you order the ventilation unit.

— Other zone: The unit may be installed in this area.

— **Build-up of icicles and ice patches at low temperatures**

The heat recovery process in our ventilation units causes condensation. This condensation is dissipated to the outside via the exhaust air pipe. When external temperatures drop below 0 °C this can cause a build-up of icicles at the outer wall terminals and ice patches on the ground.

CAUTION

— **Starting and using the ventilation unit**

- ▶ Do not start up the ventilation unit until it is fully installed.
- ▶ Always make sure that the cover is closed and locked in place before using the ventilation unit.

2.3 Notes on using the ventilation units

— This unit may be used by children from 8 years old and by persons of restricted physical, sensory or mental abilities or persons lacking experience and knowledge if they are supervised or have been instructed in how to use the unit safely and understand the associated hazards. Do not allow children to play with the unit. Cleaning and user maintenance must not be carried out by children unless they are supervised.

- ▶ Follow the regulations applicable in your country concerning the age from which people may be permitted to operate the ventilation unit.

— The ventilation unit must always be freely accessible for operation and maintenance.

- ▶ Make sure that the ventilation unit is not blocked, obstructed or covered when the room is subsequently decorated and furnished, otherwise it cannot be used and it will not be possible to replace the filter.
- ▶ Make sure that the supply and extract air openings are not blocked, obstructed or covered when the room is subsequently decorated and furnished.

2.4 Intended use

— The ventilation unit is intended for supplying air to and extracting air from living and recreation rooms (bedrooms, playrooms, living rooms, bathrooms, basement workshops, offices, consulting rooms, etc.). The ventilation unit is installed in a perpendicular position in the external wall. Any different or more extensive usage will be regarded as contrary to the intended use.

— The intended use also includes compliance with all the notes in the operating instructions.

— The ventilation unit must not be operated without a filter.

— The ventilation unit's functions may be impaired or the unit may be damaged in rooms with a lot of dust (e.g. model-making) or corrosive gas emissions (e.g. copy shop, cleaning).

— For any use contrary to the intended use, Meltem Wärmerückgewinnung GmbH & Co. KG shall accept no liability for any damage that may occur and offers no warranty that the components will work perfectly and correctly.

3 Warranty and liability

3.1 Warranty

The following cases shall invalidate the warranty:

- The installation kit was not installed as described in the installation manual.
- The ventilation unit was not installed as described in the installation manual.
- Genuine Meltem parts were not replaced with genuine parts.
- Unapproved changes were made to the installation kit or ventilation unit.
- Repairs were carried out incorrectly.
- The ventilation unit was operated without a filter.
- The warranty does not cover wearing parts such as filters.

3.2 Liability

The manufacturer's liability shall not apply in the following cases:

- The installation kit was not installed as described in the installation manual.
- The ventilation unit was not installed as described in the installation manual.
- Genuine Meltem parts were not replaced with genuine parts.
- Unapproved changes were made to the installation kit or ventilation unit.
- Repairs were carried out incorrectly.
- The ventilation unit was operated without a filter.

4 Dimensions

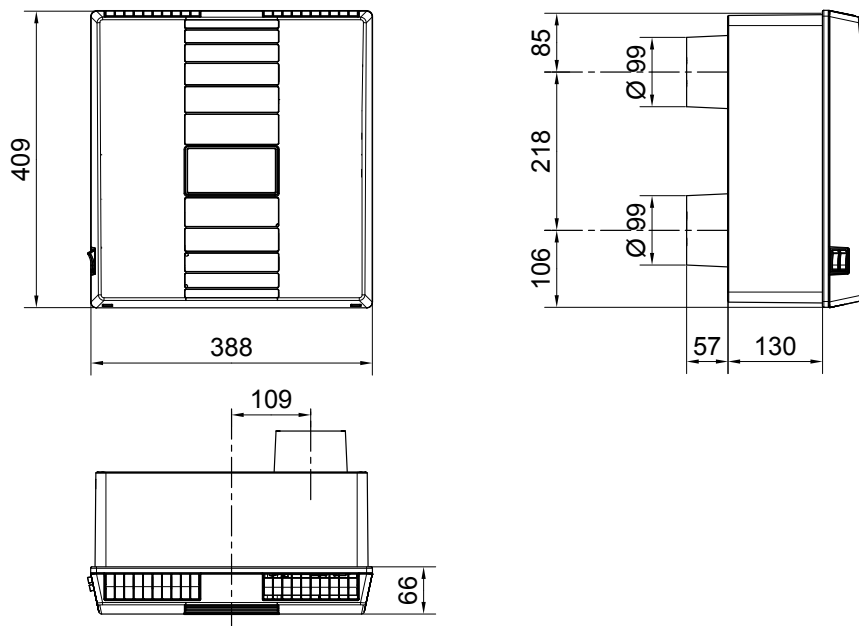

Fig. 3: Dimensions of the M-WRG-K and M-WRG-K/FC ventilation units, in millimetres

5 Structure and functions

5.1 Overview of the modules

5.1.1 Ventilation unit – cover attached

Item	Designation
1	Housing
2	Cover
3	LCD display
4	Stepping switch for three power levels + intensive ventilation level (only possible in program P0)
5	Mains switch

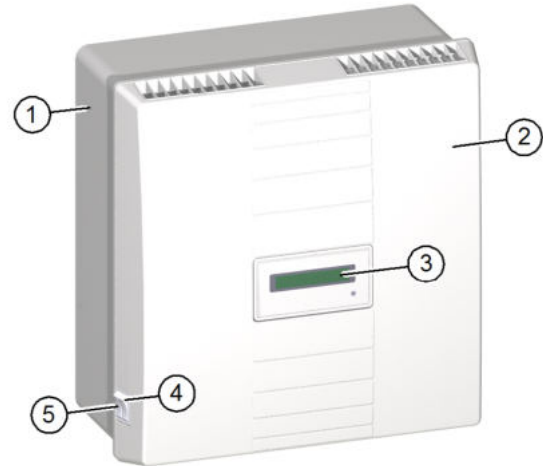

Fig. 4: Ventilation unit – cover attached

5.1.2 Ventilation unit – cover removed

Item	Designation
1	Supply air opening with air flap
2	Supply air filter with filter cover
3	Intermediate plate
4	Network connection cover
5	Supply air hood
6	Extract air filter with filter ring
7	Extract air opening with air flap

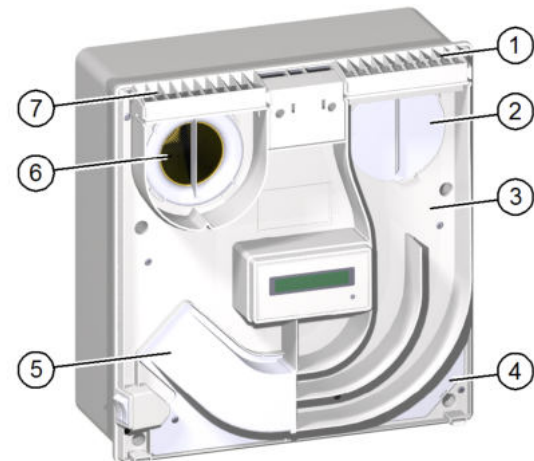

Fig. 5: Ventilation unit – cover removed

5.1.3 Outer wall terminal

Item	Designation
1	Opening for drawing in outdoor air
2	Opening for blowing out exhaust air

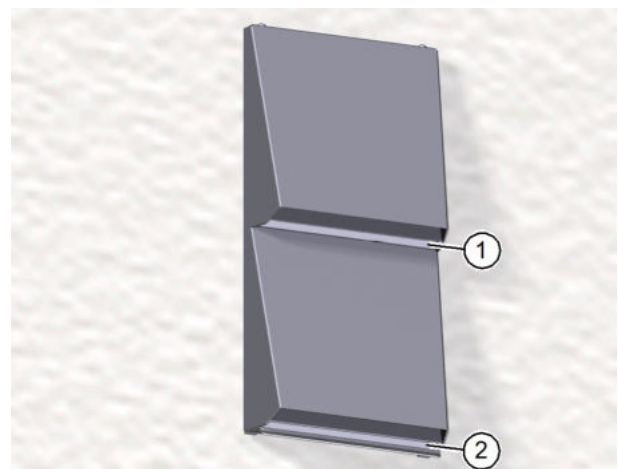

Fig. 6: Outer wall terminal

5.2 Description of the functions

5.2.1 How the M-WRG ventilation unit works

The supply air fan (item 5 in Fig. 8) transports outdoor air (item 7 in Fig. 7) through the supply air filter (item 2 in Fig. 8) and cross-flow plate heat exchanger (item 3 in Fig. 8) into the interior as supply air (item 4 in Fig. 7). The extract air fan (item 4 in Fig. 8) extracts the extract air (item 3 in Fig. 7) from the interior. In the extract air filter (item 1 in Fig. 8), the extract air is cleaned, guided through the cross-flow plate heat exchanger and carried outside as exhaust air (item 8 in Fig. 7). The supply air and extract air fans each transport the same volume of air. The pressure in the interior remains practically constant.

Item	Designation
1	M-WRG ventilation unit
2	Internal wall side
3	Extract air
4	Supply air
5	External wall side
6	Outer wall terminal
7	Outdoor air
8	Exhaust air

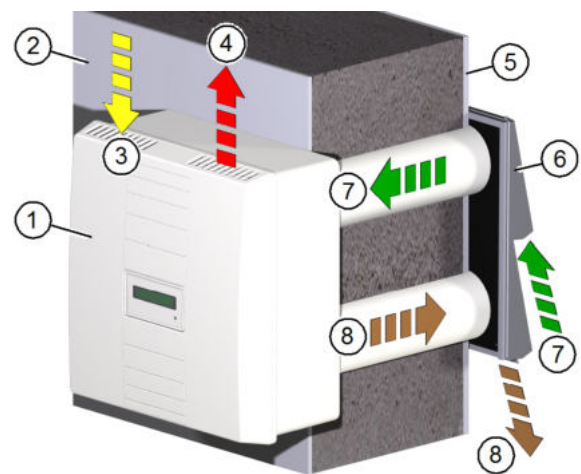

Fig. 7: How the ventilation unit works

Item	Designation
1	Extract air filter
2	Supply air filter
3	Cross-flow plate heat exchanger
4	Extract air fan
5	Supply air fan

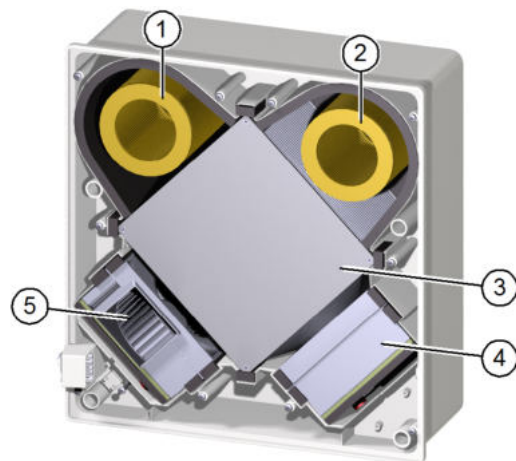

Fig. 8: Components for air exchange

5.2.2 How the cross-flow plate heat exchanger works

The warm extract air (item 5 in Fig. 9) drawn in from the interior is routed through the chambers of the cross-flow plate heat exchanger (item 1 in Fig. 9) and heats them.

The cooled extract air is carried to the outside as exhaust air (item 3 in Fig. 9).

At the same time, the cold outdoor air that is drawn in (item 2 in Fig. 9) is routed through the chambers of the cross-flow plate heat exchanger, which are separate from the extract air, and is heated. The separate chambers prevent the outdoor air and extract air from mixing.

The heated outdoor air is routed into the interior as supply air (item 4 in Fig. 9).

Item	Designation
1	Cross-flow plate heat exchanger
2	Outdoor air
3	Exhaust air
4	Supply air
5	Extract air

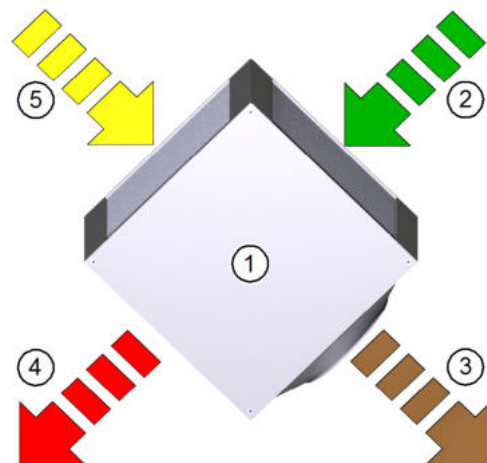

Fig. 9: How the cross-flow plate heat exchanger works

6 Rules for correct usage

6.1 General

- ▶ Run the ventilation unit in continuous operation. The constant ventilation creates a good and healthy atmosphere in the room.
- ▶ Adapt the air flow through the ventilation unit to take account of the air load created by cooking, washing, ironing, visitors, showers, sauna, etc.
- ▶ Set the ventilation unit so that the relative humidity ranges between 40 % and 65 %. People feel most comfortable within this range.

6.2 Operation in high atmospheric humidity

NOTE

- ▶ In the summer months, ventilate cellars and similar rooms only during the night. Otherwise condensation from the atmospheric humidity can cause damage due to damp on the cold walls.

6.3 Operation at cold times of year

NOTE

- ▶ During cold times of year, run the ventilation unit in continuous mode.
 - In below-zero temperatures, avoid ventilation programs that stop the fan motors for long periods.
 - Energy-saving motors and an innovative controller ensure a very low power consumption, even in continuous mode (roughly 3.8 W at the lowest level).
 - Continuous removal of moisture from the interior is only guaranteed in continuous mode.
 - The condensate is only routed outside in continuous mode.
- ▶ In the following cases, run a 10-minute ventilation burst at maximum power level:
 - regularly if there is high atmospheric humidity in the interior
 - if you need to switch off the ventilation unit.

This will remove any condensate that is present in the ventilation unit.
- ▶ Maintain the temperature in bedrooms at 16 °C to 18 °C or more. This temperature is also more healthy for the people in the bedrooms. Do not run the ventilation unit at room temperatures below 15 °C, and particularly not at low external temperatures below -5 °C. Otherwise the ventilation unit will constantly activate the frost protection or switch off altogether. The higher the interior temperature, the bigger the buffer for operating the ventilation unit and for heat recovery.

6.4 Filters

- ▶ Never run the ventilation unit without filters.
- ▶ Always use genuine Meltem filters. These are precisely matched to your M-WRG ventilation units, ensure minimal pressure losses and will ensure a long service life from your ventilation units.
- ▶ For hygiene reasons, replace both filter cartridges at least 1x every year, ideally before the period of cold weather.
- ▶ Observe the filter change indicator and replace the filters as necessary.

7 Controls and displays

7.1 Controls and displays on the ventilation unit

Item	Designation
1	Mains switch I = Ventilation unit "On" O = Ventilation unit "Off"
2	Stepping switch for 3 power levels: Power level I = 15 m ³ /h Power level II = 30 m ³ /h Power level III = 60 m ³ /h Intensive ventilation level (in P0 program only): Switching sequence I-II-I = 100 m ³ /h (15 min)
3	LCD display for status information
4	Infrared sensor for receiving user input from the infrared remote control

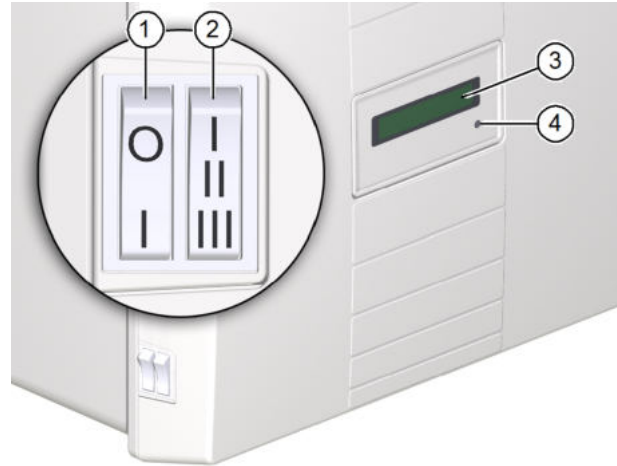
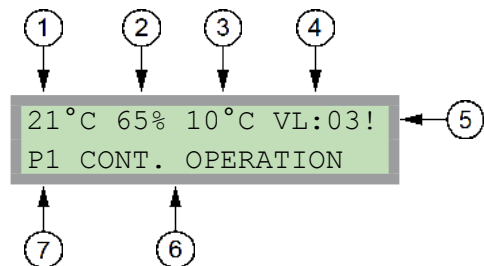

Fig. 10: Controls and displays on the ventilation unit

7.2 LCD display

Item	Designation
1	Room air temperature
2	Room air humidity
3	Outdoor air temperature
4	Ventilation level VL:01 = 15 m ³ /h VL:06 = 60 m ³ /h VL:02 = 20 m ³ /h VL:07 = 70 m ³ /h VL:03 = 30 m ³ /h VL:08 = 80 m ³ /h VL:04 = 40 m ³ /h VL:09 = 90 m ³ /h VL:05 = 50 m ³ /h VL:10 = 100 m ³ /h
5	Additional messages: ! = Filter change required * = Frost protection active
6	Brief description of the program
7	Selected program



7.3 Infrared remote control



Fig. 11: Infrared remote control

Item	Symbol	Function
1	—	LED send function display, lights up red when a button is pressed
2	⏻	On/Off, switches between Ventilation mode and Standby mode
3	⊕	Selects the next program
4	⊖	Selects the previous program
5	Ⓜ	Calls up Setup mode/Back and save
6	↶	Reduces the value
7	⏴	Selects the previous value
8	↷	Increases the value
9	⏵	Selects the next value
10	ⓄK	Starts the program/Back without saving

8 Starting up

8.1 Check ventilation unit before switching on for first time

- ▶ Check the ventilation unit for damage.
- ▶ Check that the openings for extract air and supply air are unobstructed.

8.2 Switch on the ventilation unit

- ▶ Switch the ventilation unit on at the mains switch (item 1 in Fig. 10 on page 16).
The following message appears on the LCD display (item 3 in Fig. 10 on page 16):

```
Vers.: 034.68.02.EN  
HEAT RECOVERY
```

The version number on the top line may be different from the number on your ventilation unit.

- ▶ Make a note of the version number that appears on the top line of the LCD display on your ventilation unit:

```
Vers.: . . . .
```

After approx. 10 seconds, the air flaps on the extract air and supply air openings open. When the "READY" message appears, the ventilation unit switches to ventilation program "P0" after approx. 20 seconds.

8.3 Check position of air flaps

NOTE

- ▶ Check the position of the air flaps (see Fig. 12 and Fig. 13) on the extract air and supply air openings.
 - Both air flaps will be closed if the ventilation unit is switched off or without power (see item 1 in Fig. 12).
 - Both air flaps open when you switch on (see item 1 in Fig. 13).

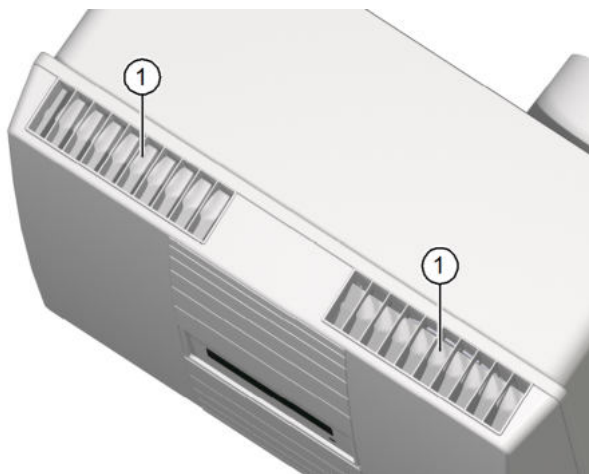

Fig. 12: Air flaps closed

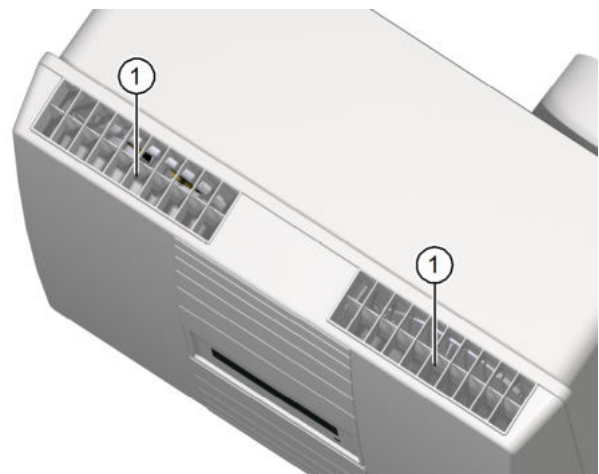

Fig. 13: Air flaps open

NOTE

If the air flaps do not open fully after switching on for the first time or after a longer stoppage, follow the steps below:

- ▶ Switch the ventilation unit off.
- ▶ Wait at least 15 seconds.
- ▶ Switch the ventilation unit on again.

The air flaps should open fully. If this is not the case, repeat the above steps.

8.4 Insert batteries in infrared remote control

- ▶ Remove the cross-head screw (item 1 in Fig. 14) on the back of the infrared remote control.
- ▶ Take the battery compartment (item 1 in Fig. 15) out of the infrared remote control.
- ▶ Insert the batteries supplied (size AAA, item 2 in Fig. 15) in the battery compartment.

NOTE

- ▶ Note the polarity signs in the battery compartment.
- ▶ Insert the battery compartment into the infrared remote control and fix in place with the cross-head screw.



Fig. 14: Open battery compartment



Fig. 15: Insert batteries

9 Operating the ventilation unit

9.1 Operation without infrared remote control – "P0" Stepping switch mode

The ventilation unit can be operated without an infrared remote control using ventilation program "P0". Using the stepping switch (item 2 in Fig. 10 on page 16) for three power levels and a time-limited intensive ventilation level, you can select the required air flow. The LCD display shows the following information:

VLE:03 VLI:03
P0 SELECT I, II, III

Switch position	Air flow	Ventilation level for extract air (VLE)	Ventilation level for supply air (VLI)
I	15 m ³ /h	01	01
II	30 m ³ /h	03	03
III	60 m ³ /h	06	06
Switching sequence I-II-I	100 m ³ /h (intensive vent. level, 15 min)	10	10

NOTE

- Selecting switching sequence I-II-I on the stepping switch within two seconds results in 15 minute of intensive ventilation at ventilation level 10 (100 m³/h). The ventilation unit then resumes operation at the previously set ventilation level.
- You can cancel intensive ventilation while it is running by selecting switching sequence I-II-I again.

9.2 Operation with infrared remote control

9.2.1 Change program

When you switch on the ventilation unit, it starts in the last selected program. Follow the steps below to select a different program:

- ▶ Press the (OK) button to exit the current program.
- ▶ Use the (+) or (−) button to navigate to the required program.
- ▶ Press the (OK) button to start the selected program.

9.2.2 Save / discard settings

- ▶ Press the (M) button to **save** settings in a menu and switch to the previous menu.
- ▶ Press the (OK) button to **discard** settings in a menu and switch to the previous menu.

NOTE

Some settings require measured values to be recorded, which takes some time. There will therefore be a delay before the ventilation unit responds to some input.

9.3 Set day and time

- ▶ Select program "P8" Settings (see section 9.2.1 on page 20).
The LCD display shows the following information:

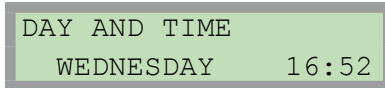

DAY AND TIME
WEDNESDAY 16:52

- ▶ Press the (M) button to switch to Setup mode.
The LCD display shows the following information:

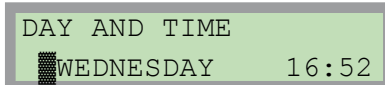

DAY AND TIME
WEDNESDAY 16:52

The flashing cursor highlights the current value to be changed. At the start, the cursor is on the day of the week.

- ▶ Use the (↶+) or (↷-) button to set the required day.
- ▶ Press the (↑) button to move to the next value.
- ▶ Use the (↶+) or (↷-) button to set the hour of the current time.
- ▶ Press the (↑) button to move to the next value.
- ▶ Use the (↶+) or (↷-) button to set the minute of the current time.
- ▶ Press the (↓) button to move back to the previous value, if necessary.
- ▶ Press the (M) button to save the setting.
- ▶ Press the (OK) button 3x to exit the settings.

NOTE

- If you have not set the day and time, **the backlight flashes** on the LCD display.
- The ventilation unit's time will stop running in the following situations:
 - if the power fails
 - if the ventilation unit was switched off at the mains switch.

For example, the current time on the ventilation unit will be 20 minutes slow after a 20-minute power cut. Saved program settings are retained.

- ▶ Update the time and the day of the week, if necessary.

- The ventilation unit does not automatically switch between summer and winter time.
- The "P3" Day/week and "P7" Ventilation programs require the day and time to be set correctly.
- We recommend that you do not use "P3" Day/week program and "P7" Ventilation program if you are using the ventilation unit in conjunction with a safety device, such as a differential pressure monitor. If the safety device interrupts the power supply to the ventilation unit, the time on the ventilation unit will stop running, so the ventilation programs will no longer work at the required times.

10 Ventilation programs

This section describes the available ventilation programs and their settings. The values in the illustrated LCD displays are given by way of example and depend on the actual ambient conditions and set values.

10.1 "P0" Stepping switch mode

Purpose:

Ventilation program "P0" allows the unit to be operated without a remote control (see section 9.1 on page 20).

Setting:

- ▶ Select ventilation program "P0" (see section 9.2.1 on page 20).
- ▶ Use the stepping switch to select the required air flow (see section 9.2.1 on page 20).

10.2 "P1" Continuous operation

Purpose:

Ventilation program "P1" is a continuous ventilation program (24 hours) for ventilation with heat recovery. Ventilation level $V_L:03$ is preset at the factory.

Setting:

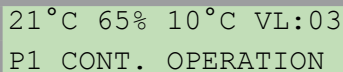

- ▶ Select ventilation program "P1" (see section 9.2.1 on page 20).

The LCD display shows the following information:



21°C 65% 10°C VL:03
P1 CONT. OPERATION

Temporarily set the ventilation level:

- ▶ Use the  or  button to set the required ventilation level.

This setting is retained until you exit ventilation program "P1". If you select "P1" again, the permanently saved setting will still apply.

Permanently set the ventilation level:



- ▶ Press the  button to switch to Setup mode.

The LCD display shows the following information:



VENT. LEVEL VL:03

The flashing cursor highlights the current value to be changed. At the start, the cursor is on the ventilation level to be set.

- ▶ Use the  or  button to set the required ventilation level.
- ▶ Press the  button to save the setting and start the ventilation program.

10.3 "P2" Interval program

Purpose:

Ventilation program "P2" runs the ventilation alternating between the set intervals ("Running" and "Pause"). You can set the required ventilation level and the ventilation duration for both intervals.

Setting:

- ▶ Select ventilation program "P2" (see section 9.2.1 on page 20).

The LCD display shows the following information:

21°C 65% 10°C VL:03 P2 RUNNING 00:59	or	21°C 65% 10°C VL:01 P2 PAUSE BVL 00:29
---	----	---

- P2 RUNNING 00:59 means that the ventilation unit is in ventilation program P2 in the RUNNING interval with a remaining time of 59 minutes.
- P2 PAUSE BVL 00:29 means that the ventilation unit is in ventilation program P2 in the PAUSE interval at the basic ventilation level (BVL) with a remaining time of 29 minutes.

Set the running interval, pause interval and ventilation levels:

- ▶ Press the (M) button to switch to Setup mode.

The LCD display shows the following information:

RUNNING 01:00 VL:03
PAUSE 00:30 VL:01

The flashing cursor highlights the current value to be changed. At the start, the cursor is on the hours value of the running interval.

- ▶ Use the (←) or (→) button to set the required hours duration for the running interval.
- ▶ Press the (↑) button to move to the next value.
- ▶ Use the (←) or (→) button to set the required minutes duration for the running interval.
- ▶ Press the (↑) button to move to the next value.
- ▶ Use the (←) or (→) button to set the required ventilation level for the running interval.
- ▶ Repeat the above steps for the pause interval.
- ▶ Press the (↓) button to move back to the previous value, if necessary.
- ▶ Press the (M) button to save the setting and start the ventilation program.

NOTE

- ▶ In the pause interval, select ventilation level VL:00 if you want to stop the ventilation. In this case, the ventilation unit will simply display P2 PAUSE and the remaining time. The lowest ventilation level in the Running interval is VL:01.

10.4 "P3" Day/week program

Purpose:

Ventilation program "P3" allows the ventilation unit to be individually customized to the user's personal schedules. You can enter up to three different ventilation periods with different ventilation levels for each day. Between the set ventilation periods, the ventilation unit automatically switches to Pause mode.

Setting:

- ▶ Select ventilation program "P3" (see section 9.2.1 on page 20).

The LCD display shows the following information:

21°C 65% 10°C VL:03
P3 RUNNING TH 10:25

or

P3 PAUSE TH 00:29

- P3 RUNNING TH 10:25 means that the ventilation unit is in ventilation program P3 with the status RUNNING. The current day and time are also displayed.
- P3 PAUSE TH 00:29 means that the ventilation unit is in ventilation program P3 with the status PAUSE. The current day and time are also displayed.

Configure ventilation periods:



- ▶ Press the (M) button to switch to Setup mode.

The LCD display shows the following information:

MONDAY TIME: 1
21:30 - 22:30 VL:03

The flashing cursor highlights the current value to be changed. At the start, the cursor is on the day of the week.

- ▶ Use the (↶+) or (↷-) button to set the required day.
- ▶ Press the (↑) button to move to the next value.
- ▶ Use the (↶+) or (↷-) button to set the required ventilation period 1, 2 or 3 for the day.
- ▶ Press the (↑) button to move to the next value.
- ▶ Use the (↶+) or (↷-) button to set the hour for the start time.
- ▶ Press the (↑) button to move to the next value.
- ▶ Use the (↶+) or (↷-) button to set the minutes for the start time.
- ▶ Press the (↑) button to move to the next value.
- ▶ Use the (↶+) or (↷-) button to set the hour for the stop time.
- ▶ Press the (↑) button to move to the next value.
- ▶ Use the (↶+) or (↷-) button to set the minutes for the stop time.
- ▶ Press the (↑) button to move to the next value.
- ▶ Use the (↶+) or (↷-) button to set the required ventilation level.

- ▶ Press the  button to move back to the previous value, if necessary.
- ▶ Press the  button to save the setting.
- ▶ Configure a new time interval or press the  button to cancel the input and start the ventilation program.

NOTE

- Ventilation program "P3" requires a correctly set time on the ventilation unit (see notes in section 9.3 on page 21).
- Set the start and end to the same time to temporarily deactivate a ventilation period. For more significant configuration changes, we recommend that you reconfigure the day.
- Before configuring a week cycle for the first time, it will be useful to note down the pattern of all the start and end times.
- Ventilation periods 1, 2 and 3 for a day must be entered in the correct chronological order. If ventilation period 1 contains the stop time 22:00, the start time in ventilation period 2 cannot start earlier. The ventilation unit will not accept invalid input.

10.5 "P4" Humidity program

Purpose:

Ventilation program "P4" automatically draws air into and out of the room in relation to the room air humidity. People feel most comfortable if the relative humidity (RH) ranges between 40 % and 65 %.

Sequence:

The ventilation unit is running constantly in basic ventilation mode ($V_{Lmin}:01$, factory setting). The temperature and relative humidity of the extract air (room air) and supply air are measured. If the relative humidity of the room air exceeds the set threshold (e.g. 65 % relative humidity, factory setting), the ventilation unit calculates the optimum change of air and automatically sets the necessary ventilation level. This is gradually increased up to the maximum ventilation level ($V_{Lmax}:06$, factory setting). When the relative humidity reaches the threshold, the ventilation level is gradually reduced to $V_{Lmin}:01$ (factory setting).

NOTE

The ventilation unit will only work automatically if the relative humidity of the supply air is lower than that of the room air. The measured atmospheric humidity of the supply air is calculated in relation to the room air temperature.

Setting:

- ▶ Select ventilation program "P4" (see section 9.2.1 on page 20).

The LCD display shows the following information:

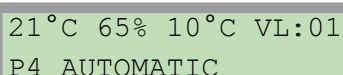



21°C 65% 10°C VL:01
P4 AUTOMATIC

P4 AUTOMATIC means that the ventilation unit is in ventilation program "P4" in automatic mode.

Manual mode:

In Manual mode you can temporarily set the ventilation level to a value between VL:01 and VL:10.

- ▶ Use the  or  button to set the required ventilation level in order to switch from Automatic to Manual mode.

The LCD display shows the following information:

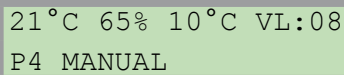

21°C 65% 10°C VL:08
P4 MANUAL

- ▶ Press the  button to return to Automatic mode.

Configure Automatic mode:











- ▶ Press the  button to switch to Setup mode.

The LCD display shows the following information:



VLmin:01 VLmax:06
THRESHOLD 60%RH

The flashing cursor highlights the current value to be changed. At the start, the cursor is on the basic ventilation level VLmin.

- ▶ Use the  or  button to set the required ventilation level for basic ventilation VLmin. Select a value between ventilation level 0 and 3.
- ▶ Press the  button to move to the next value.
- ▶ Use the  or  button to set the required ventilation level for dehumidification mode VLmax. Select a value between ventilation level 3 and 10.
- ▶ Press the  button to move to the next value.
- ▶ Use the  or  button to set the required THRESHOLD for automatic regulation. Select a value between 40 % and 70 % relative humidity.
- ▶ Press the  button to move back to the previous value, if necessary.
- ▶ Press the  button to save the setting and start the ventilation program.

10.6 "P5" Temperature program

Purpose:

With ventilation program "P5", the ventilation unit is only in operation if the temperature of the supply air does not exceed or fall below a customisable range. This mode of operation can be useful on hot summer days or very cold winter days.

Sequence:

You can select a temperature range for the supply air between +5 °C (min.) and +30 °C (max.). While the temperature of the supply air remains in the set range, the ventilation unit will work. If the temperature exceeds or falls below the set range, the ventilation unit will switch to Pause mode, the air flaps are closed and the LCD display contains the following information:



P5 SENSOR

Every hour, the unit starts a five-minute sensor run in order to record the measured values. The unit will remain in operation or switch to Pause mode according to the measured temperature.

NOTE

- ▶ Please note that the set temperature range relates to the supply air, rather than the outdoor air.
 - Example 1: The set temperature range for the supply air is between +10 °C and +25 °C. The temperature of the outdoor air is +30 °C. The ventilation unit remains in ventilation mode for as long as the outdoor air is cooled to below +25 °C via the cross-flow plate heat exchanger.
 - Example 2: The set temperature range for the supply air is between +10 °C and +25 °C. The temperature of the outdoor air is +5 °C. The ventilation unit remains in ventilation mode for as long as the outdoor air is heated to above +10 °C via the cross-flow plate heat exchanger.

Setting:

- ▶ Select ventilation program "P5" (see section 9.2.1 on page 20).
The ventilation unit starts a five-minute sensor run. The LCD display shows the following information:

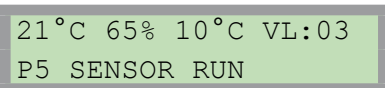

21 °C 65% 10 °C VL:03
P5 SENSOR RUN





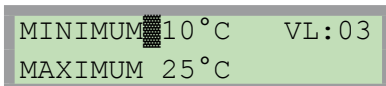





Configure Temperature program:

- ▶ Press the **(M)** button to switch to Setup mode.
The LCD display shows the following information:



MINIMUM 10 °C VL:03
MAXIMUM 25 °C

The flashing cursor highlights the current value to be changed. At the start, the cursor is on the MINIMUM for the supply air temperature.

- ▶ Use the  or  button to set the required minimum supply air temperature. Select a value between +5 °C and +25 °C. The **MINIMUM** cannot be higher than the **MAXIMUM**.
- ▶ Press the  button to move to the next value.
- ▶ Use the  or  button to set the required maximum supply air temperature. Select a value between +10 °C and +30 °C. The **MAXIMUM** cannot be lower than the **MINIMUM**.
- ▶ Press the  button to move to the next value.
- ▶ Use the  or  button to set the required ventilation level. Select a value between ventilation level 1 and 10.
- ▶ Press the  button to move back to the previous value, if necessary.
- ▶ Press the  button to save the setting and start the ventilation program. The settings do not take effect until the five-minute sensor run has ended.

10.7 "P6" Air quality

NOTE

- Ventilation program "P6" Air quality is only available on the M-WRG-K/FC ventilation unit.
- When it is started up for the first time, the ventilation unit must remain switched on for at least 4 hours without interruption so that the CO₂ and mixed gas sensor can be calibrated.
 - ▶ Make sure that the air is not severely contaminated during the calibration phase by solvents, for example.
- When you switch on again, it will take roughly 15 minutes for the sensor to recalibrate.

Purpose:

Ventilation program "P6" uses a CO₂ and mixed gas sensor to monitor the air quality and automatically ensures an optimum air exchange and continuous removal of air pollutants. The carbon dioxide (CO₂) that is breathed out by people impairs the air quality in high concentrations. Consequences include concentration problems and tiredness. However, they can also be caused by odours or volatile organic compounds (VOCs), such as those that outgas from cleaning agents, paints or fitments. VOCs can be harmful to the health in higher concentrations or if you stay in such rooms for long periods. The ventilation unit automatically reduces the pollution concentration to a minimum via the air exchange, and thus ensures good room air quality.

Sequence:

The ventilation unit continuously measures the air quality via a CO₂ and mixed gas sensor, and ventilates at the set ventilation level V_{Lmin} . If the pollutant concentration exceeds the variable threshold, the ventilation unit calculates the optimum air exchange and automatically sets the necessary ventilation level to V_{Lmax} . Ventilation is limited to the extent that is actually needed. This also improves the energy-efficiency of your ventilation unit.

DIN EN 13779 divides the room air quality into four levels, according to the CO₂ concentration:

- At values below 800 ppm, the room air quality is high.
- At values between 800 and 1000 ppm, the room air quality is average.
- At values between 1000 and 1400 ppm, the room air quality is moderate.
- At values above 1400 ppm, the room air quality is low.

Setting:

- ▶ Select ventilation program "P6" (see section 9.2.1 on page 20).



The LCD display shows the following information:

```
21°C 65% 10°C VL:01
P6 AUTOMATIC 450ppm
```

P6 AUTOMATIC means that the ventilation unit is in ventilation program "P6" in Automatic mode.

Manual mode:

In Manual mode you can temporarily set the ventilation level to a value between VL:01 and VL:10.

- ▶ Use the  or  button to set the required ventilation level in order to switch from Automatic to Manual mode.

The LCD display shows the following information:

```
21°C 65% 10°C VL:08
P6 MANUAL 450ppm
```

- ▶ Press the  button to return to Automatic mode.









Configure Automatic mode:

- ▶ Press the  button to switch to Setup mode.

The LCD display shows the following information:

```
VLmin:01 VLmax:06
THRESHOLD 650ppm
```

The flashing cursor highlights the current value to be changed. At the start, the cursor is on the basic ventilation level VLmin.

- ▶ Use the  or  button to set the required ventilation level for basic ventilation VLmin. Select a value between 0 and 3.
- ▶ Press the  button to move to the next value.
- ▶ Use the  or  button to set the required ventilation level for ventilation mode VLmax. Select a value between 3 and 10.
- ▶ Press the  button to move to the next value.
- ▶ Use the  or  button to set the required THRESHOLD for automatic regulation. Select a value between 500 and 1200 ppm in 50 ppm increments. The factory default is 600 ppm.

- ▶ Press the \downarrow button to move back to the previous value, if necessary.
- ▶ Press the $\textcircled{\text{M}}$ button to save the setting and start the ventilation program.

10.8 "P7" Ventilation program (cross-ventilation with two ventilation units)

Purpose:

Ventilation program "P7" is used for cross-ventilation between two rooms with two ventilation units - known as an interconnected air system. For example, you can set up cross-ventilation from the bedroom to the bathroom in order to transport cool outdoor air into the house at night in summer. In contrast to all the other programs, the extract air (VLE) and supply air (VLI) ventilation levels can be set differently (see Fig. 16).



Fig. 16: Cross-ventilation with two ventilation units

NOTE

- Ventilation program "P7" requires the time to be set correctly on the ventilation unit (see notes in section 9.3 on page 21).
- Ventilation program "P7" is not suitable for cold times of year with external temperatures below +10 °C.
- If the ventilation unit is operated with an excess of supply air with a high proportion of cold air, the ventilation program may be interrupted by the integrated frost protection function.
- Adequately-sized overflow openings between the rooms are needed for cross-ventilation, for example:
 - Open doors
 - An air gap of 5 - 10 mm between the door and floor
- The sum of the air volumes supplied $VLI_1 + VLI_2$ ($03 + 01 = 04$) must be equal to the sum of the air volumes removed $VLE_1 + VLE_2$ ($01 + 03 = 04$) (see Fig. 16).
- The status displays for temperature, atmospheric humidity, etc. can differ slightly on the two ventilation units as they relate to information for the respective rooms and exterior air temperatures.
- The heat recovery effect lessens as the values for the extract air (VLE) and supply air (VLI) ventilation levels move apart.
- ▶ For hygiene reasons, do not route the laden air from bathrooms, toilets or kitchens through the bedroom or living room.

- ▶ Generate an air flow (see Fig. 16) that flows from a room with unladen air (e.g. bedroom) into a room with laden air (e.g. bathroom).
- ▶ Please note that it is not possible to set the ventilation level $V_L:00$ for extract air and supply air.

Controlling the air flow:

Varying the settings for the extract air and supply air ventilation levels allows you to determine the direction of the air flow (see also Fig. 16 on page 30). The air should flow from ventilation unit 1 (start of the air flow) to ventilation unit 2 (destination of the air flow).

- ▶ To do this, make the following settings:

	Ventilation unit 1, start of the air flow	Ventilation unit 2, destination of the air flow
Ventilation level for extract air (V_{LE})	low, e.g. 01	high, e.g. 03
Ventilation level for supply air (V_{LI})	high, e.g. 03	low, e.g. 01

Setting:

- ▶ Select ventilation program "P7" (see section 9.2.1 on page 20).

The LCD display shows the following information:

21°C 65% 10°C $V_{LE}:1$ IN AIR:03 TIME 08:00	or	21°C 65% 10°C $V_L:03$ P7 PAUSE BVL - 22:00
--	----	--























- The left-hand LCD display shows the settings for Night mode which is configured at the factory from 22:00 to 06:00.
 $V_{LE}:1$ and IN AIR:03 TIME 08:00 means that ventilation level 1 was selected for the extract air and ventilation level 3 for the supply air. The ventilation unit is in Night mode with a remaining time of 8 hours.
- The right-hand LCD display shows the settings for day mode (PAUSE) which is configured at the factory from 06:01 to 21:59.
 $V_L:03$ and P7 PAUSE BVL - 22:00 means that the ventilation unit is in program P7 in Day mode (PAUSE) at basic ventilation level (BVL) 3. Day mode (PAUSE) lasts until 22:00.

Configure Day and Night mode:

- ▶ Press the (M) button to switch to Setup mode.
The LCD display shows the following information:

V_{LE} 01 $V_{LI}:03$ $V_L:01$ ON 22:00 TIME 08:00

The flashing cursor highlights the current value to be changed. At the start, the cursor is on the ventilation level for extract air V_{LE} for Night mode.



- ▶ Use the  or  button to set the required ventilation level for extract air V_{LE} for Night mode. Select a value between ventilation level 1 and 10.
- ▶ Press the  button to move to the next value.
- ▶ Use the  or  button to set the required ventilation level for supply air V_{LI} for Night mode. Select a value between ventilation level 1 and 10.
- ▶ Press the  button to move to the next value.
- ▶ Use the  or  button to set the required ventilation level for Day mode (PAUSE) V_L . Select a value between ventilation level 0 and 10.
- ▶ Press the  button to move to the next value.
- ▶ Use the  or  button to set the hour for the start time ON for Night mode.
- ▶ Press the  button to move to the next value.
- ▶ Use the  or  button to set the minutes for the start time ON for Night mode.
- ▶ Press the  button to move to the next value.
- ▶ Use the  or  button to set the required number of hours for the duration of Night mode $TIME$.
- ▶ Press the  button to move to the next value.
- ▶ Use the  or  button to set the required number of minutes for the duration of Night mode $TIME$.
- ▶ Press the  button to move back to the previous value, if necessary.
- ▶ Press the  button to save the setting and start the ventilation program.

NOTE

If you want permanent cross-ventilation in summer, for example, set the ventilation level for Day mode (PAUSE) to $V_L:00$ and select $TIME\ 23:59$ for the duration of Night mode.

11 Additional functions

11.1 Set ventilation unit to Standby mode

- ▶ Press the  button to switch from Ventilation mode to Standby mode.
This triggers the following actions:
 - The current ventilation mode is ended.
 - The ventilation unit continues to be supplied with power.
 - All settings such as the current time, day, etc. are retained.
 - The air flaps close or remain open, depending on the setting in the „11.3.3 Close flaps in pause mode“ on page 35 menu.
- ▶ Press the  button again to switch from Standby to Ventilation mode.

NOTE

It is not a good idea to leave the ventilation unit in Standby mode for long periods (see „6 Rules for correct usage“ on page 14).

11.2 Set language

The language setting menu offers the following languages:

- DE-German
- EN-English
- FR-French
- IT-Italian

There are two ways to access the language setting menu:

- If the ventilation unit is switched off:
 - ▶ Switch the ventilation unit on at the mains switch (item 1 in Fig. 10 on page 16).
The following message appears on the LCD display after the version number:





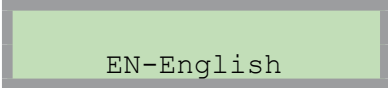

READY

- ▶ Press the  button to switch to the language setting menu.
The currently set language appears on the LCD display, e.g.:



EN-English

- ▶ Use the  or  button to set the required language.
- ▶ Press the  button to save the setting.
The ventilation unit changes to the new language and switches to Standby.
- ▶ Press the  button to switch from Standby to program selection.

— If the ventilation unit is in operation:

- ▶ Press the  button to switch from Ventilation mode to Standby mode.

The following message appears on the LCD display:



- ▶ Press the  button and continue as described above to change the language.

11.3 "P8" Settings

11.3.1 Set day and time

Setting the day and time is described in section „9.3 Set day and time“ on page 21.

11.3.2 Frost protection function

The ventilation unit is equipped with a frost protection function. In low outdoor temperatures, the ventilation unit automatically switches to frost protection mode.

- ▶ Do not switch the ventilation unit off in the winter. Note section „6 Rules for correct usage“ on page 14.
- ▶ We recommend that you activate the frost protection with “ON”.

How it works (extract from the national technical approval Z-51.3-138):

To prevent the heat exchanger from icing up, there is a temperature sensor fitted on the exhaust air side for constantly monitoring the temperature. If the exhaust air temperature drops below 2 °C, the motor controller gradually changes the supply air and/or extract air volume flow according to the fan level so that the proportion of extract air is increased. This causes the temperature to rise on the exhaust air side. When an exhaust air temperature of 4 °C is maintained for a period of 3 minutes, the unit switches back to the previous operating state. If a temperature of 2 °C is not achieved on the exhaust air side, despite increasing the proportion of extract air, e.g. because the room has cooled down, the extract air and supply air fans are switched off. As soon as a value of 4 °C is identified at the exhaust air temperature sensor, Ventilation mode is resumed at the fan level that was set before it was switched off.

Configure frost protection:

- ▶ Select program "P8" Settings (see section 9.2.1 on page 20).
The LCD display shows the following information:

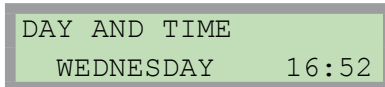

DAY AND TIME
WEDNESDAY 16:52

- ▶ Press the **(OK)** button 1x.
The LCD display shows the following information:

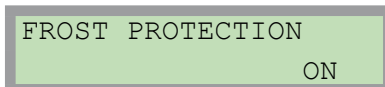

FROST PROTECTION
ON

- ▶ Press the **(M)** button to switch to Setup mode.
- ▶ Use the **(+)** or **(-)** button to activate or deactivate the frost protection.
- ▶ Press the **(M)** button to save the setting.
- ▶ Press the **(OK)** button 2x to exit the settings.

11.3.3 Close flaps in pause mode

The air flaps are opened and closed by a servomotor. This operation causes a slight noise emission that some people perceive as annoying.

It is therefore possible to suppress the closing of the air flaps in Pause mode.

In the factory setting, the air flaps are closed in Pause mode. In this position, the noise nuisance from the outside is reduced, and both air ducts are sealed off.

Configure "Close flaps in Pause mode":

- ▶ Select program "P8" Settings (see section 9.2.1 on page 20).
The LCD display shows the following information:

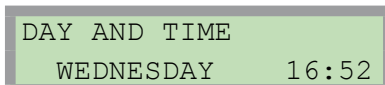

DAY AND TIME
WEDNESDAY 16:52

- ▶ Press the **(OK)** button 2x.
The LCD display shows the following information:

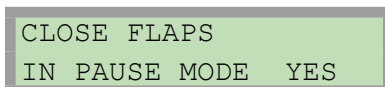

CLOSE FLAPS
IN PAUSE MODE YES

- ▶ Press the **(M)** button to switch to Setup mode.
- ▶ Use the **(+)** or **(-)** button to activate or deactivate closing of the flaps in Pause mode.
- ▶ Press the **(M)** button to save the setting.
- ▶ Press the **(OK)** button 1x to exit the settings.

11.4 "P9" Operating hours

The operating hours display shows how long the ventilation unit has been running in hours. The operating time means only the time during which the fan motors are running.

Call up operating hours display:

- ▶ Select program "P9" Operating hours (see section 9.2.1 on page 20).
The LCD display shows the following information:

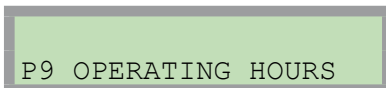

P9 OPERATING HOURS

- ▶ Press the  button.
The LCD display shows the following information:

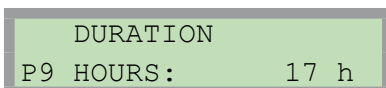

DURATION
P9 HOURS: 17 h

- ▶ Press the  button to exit the operating hours display.

NOTE

- ▶ When there is a change of user in the residential unit, it is a good idea to take a note of the operating hours as the display cannot be reset to zero, and subsequent operating hours will be added to this total.
- ▶ Note that the operating hours are updated every 4 hours.

12 Filter maintenance

The ventilation unit has a filter change indicator. The level of soiling of the round filter cartridges is automatically monitored by the ventilation unit. A pending filter change is signalled both visually and audibly roughly 2 to 3 weeks in advance.

The visual indication takes the form of an exclamation mark "!" in the top right corner of the LCD display in all program and status displays:

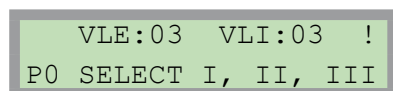

As the time for the filter change approaches, the intervals between the audible warnings shorten. The filters must be changed when the warning signal occurs every hour and lasts for one second. This long warning period allows the user to order replacement filters in good time. No tools are needed to change the filters.

12.1 Choice of filter

There are several filter classes available for the M-WRG-K ventilation unit:

Part no.	Designation	Filter type	Filter class	Application
5571	M-WRG-FS	Standard filter (for supply air and extract air)	G4	Normal use
5572	M-WRG-FA	Allergy filter (for supply air only)	F7	For people with allergies
5573	M-WRG-FK	Activated charcoal filter (for supply air only)	M6	For outdoor air polluted by cars, industry, domestic fuel, etc.

12.2 Ordering filters

Please contact your local dealer for information on ordering filters. You will find the contact details on our website at www.meltem.com (or using the QR code on this page).



Go to
www.meltem.com

12.3 Filter change

NOTE

- ▶ Always replace filters in pairs, at least once per year and ideally before the period of cold weather. The permeability of both filters affects the efficiency and power consumption of the ventilation unit.
- ▶ Always switch the ventilation unit off at the mains switch for the filter change. Otherwise the open air flaps will make it impossible to remove and insert the filter cartridges.

12.3.1 Remove cover from ventilation unit

- ▶ Using both thumbs, press the two latches (item 1 in Fig. 17) on the bottom of the ventilation unit. The cover will come away.
- ▶ At the same time, push your index fingers into the gap between the cover and housing, and lift the cover up from the housing.



Fig. 17: Remove cover from the ventilation unit

12.3.2 Remove filter

- ▶ Turn the filter ring (item 1 in Fig. 18) using the hand grip (item 2 in Fig. 18) anti-clockwise until the arrow on the filter ring (item 3 in Fig. 18) lines up with the arrow at the removal position (item 4 in Fig. 18).
- ▶ Pull the filter ring together with the extract air filter out of the ventilation unit.
- ▶ Turn the filter cover (item 6 in Fig. 18) using the hand grip (item 7 in Fig. 18) anti-clockwise until the arrow (item 8 in Fig. 18) on the filter cover lines up with the arrow at the removal position (item 9 in Fig. 18).
- ▶ Pull the filter cover together with the supply air filter out of the ventilation unit.
- ▶ Detach the extract air filter from the filter ring.
- ▶ Detach the supply air filter from the filter cover.
- ▶ Clean the filter ring and filter cover with a damp cloth if they are dirty (see section 13).

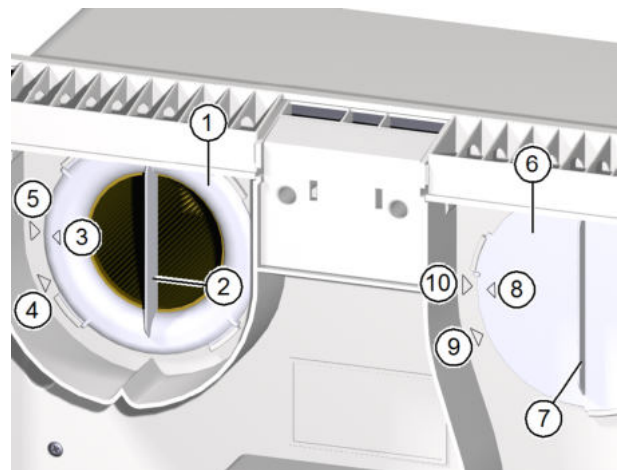

Fig. 18: Remove filter

12.3.3 Insert new filters

- ▶ Carefully guide the extract air filter into the ventilation unit.
- ▶ Make sure that the filter slides into the four retaining tabs (item 1 in Fig. 19) on the back wall of the ventilation unit.
- ▶ Place the filter ring on the extract air filter. Make sure that the filter ring lies flat on the intermediate plate (item 2 in Fig. 19).
- ▶ Make sure that the filter ring is oriented so that the arrow on the filter ring (item 3 in

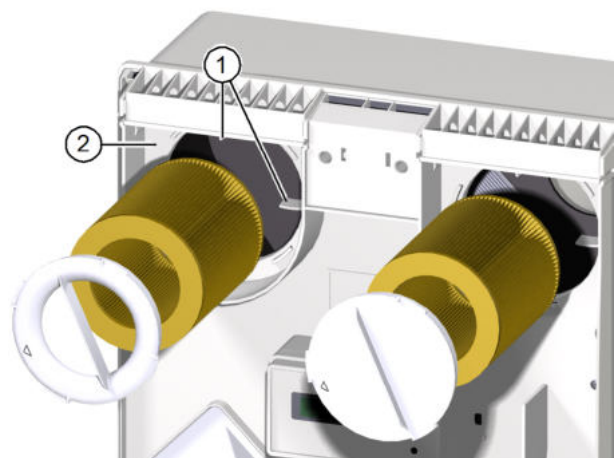

Fig. 19: Insert filter

Fig. 18 on page 38) lines up with the arrow for the removal position (item 4 in Fig. 18 on page 38).

- ▶ Turn the filter ring clockwise until the arrow on the filter ring (item 3 in Fig. 18 on page 38) lines up with the arrow for the locking position (item 5 in Fig. 18 on page 38).
- ▶ Insert the new supply air filter. Repeat the steps described for the extract air filter.
- ▶ Check the position of the filter ring and filter cover. The hand grips must be vertical and the arrows on the filter ring and filter cover must line up with the arrows for the locking position (see Fig. 18 on page 38).

NOTE

- The ventilation unit will not work as well if the filter ring or filter cover is not inserted correctly.
- Allergy filters and activated charcoal filters may only be used as supply air filters.

12.3.4 Attach cover to ventilation unit

- ▶ Hold the cover (item 1 in Fig. 20) of the ventilation unit with both hands and tilt the top edge of the cover towards the ventilation unit.
- ▶ Insert the tabs (item 2 in Fig. 20) of the cover into the openings (item 3 in Fig. 20) on the top of the ventilation unit.
- ▶ Lightly press the bottom edge of the cover against the ventilation unit until you hear the cover snap in place.

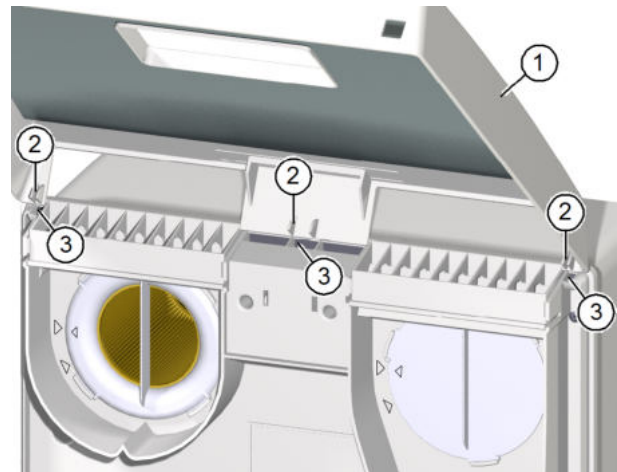

Fig. 20: Attach cover to ventilation unit

13 Cleaning

WARNING

- ▶ Switch off the power to the ventilation unit before cleaning.
- ▶ When cleaning, make sure that no moisture penetrates into the inside of the housing.
- ▶ Never use a high pressure cleaner, steam cleaner or steam jet.

The ventilation unit is made of high quality plastic and requires little care.

- ▶ Wipe the outer surfaces from time to time with a soft, damp cloth. Use mild soapy water. A commercially available plastic cleaner can be used for particularly stubborn dirt.

NOTE

- ▶ Never use acidic, corrosive or abrasive cleaning agents.

14 Troubleshooting

Error	Cause	Remedy
Ventilation unit is not running	Ventilation unit is in safe mode after an EMC fault	Switch the ventilation unit off, wait 15 seconds, then switch on
	Installation error	Have the wiring checked by a qualified electrician
	Faulty switch, motor or controller	Check by a qualified electrician
Air flaps do not open after switching on	After a long stoppage or when starting up for the first time, the servomotor is not powered by the electronic circuit.	Switch the ventilation unit off and on again
	Air flap range of motion is blocked by foreign bodies (plaster, polystyrene, etc.)	Carefully remove the foreign bodies, remove the cover if necessary (see „12.3.1 Remove cover from ventilation unit“ on page 38)
Ventilation unit starts to chirp at intervals	Filter is dirty	Change the filter (see „12.3 Filter change“ on page 37)
The ventilation unit frequently activates the frost protection		
The ventilation unit does not respond to the infrared remote control	Batteries are flat or not inserted correctly	Insert new batteries or check the battery position (see „8.4 Insert batteries in infrared remote control“ on page 19)
The ventilation unit does not switch to ventilation program "P3" or "P7" at the set times	Wrong time due to power failure or because the ventilation unit was switched off at the mains switch	Set the day and time in program "P8" (see „9.3 Set day and time“ on page 21)
Backlight on LCD display flashes	Day and time not set	Set the day and time in program "P8" (see „9.3 Set day and time“ on page 21)
Faulty LCD display	Software error	Switch the ventilation unit off at the mains switch for roughly 30 seconds and switch on again

15 Overview of the programs

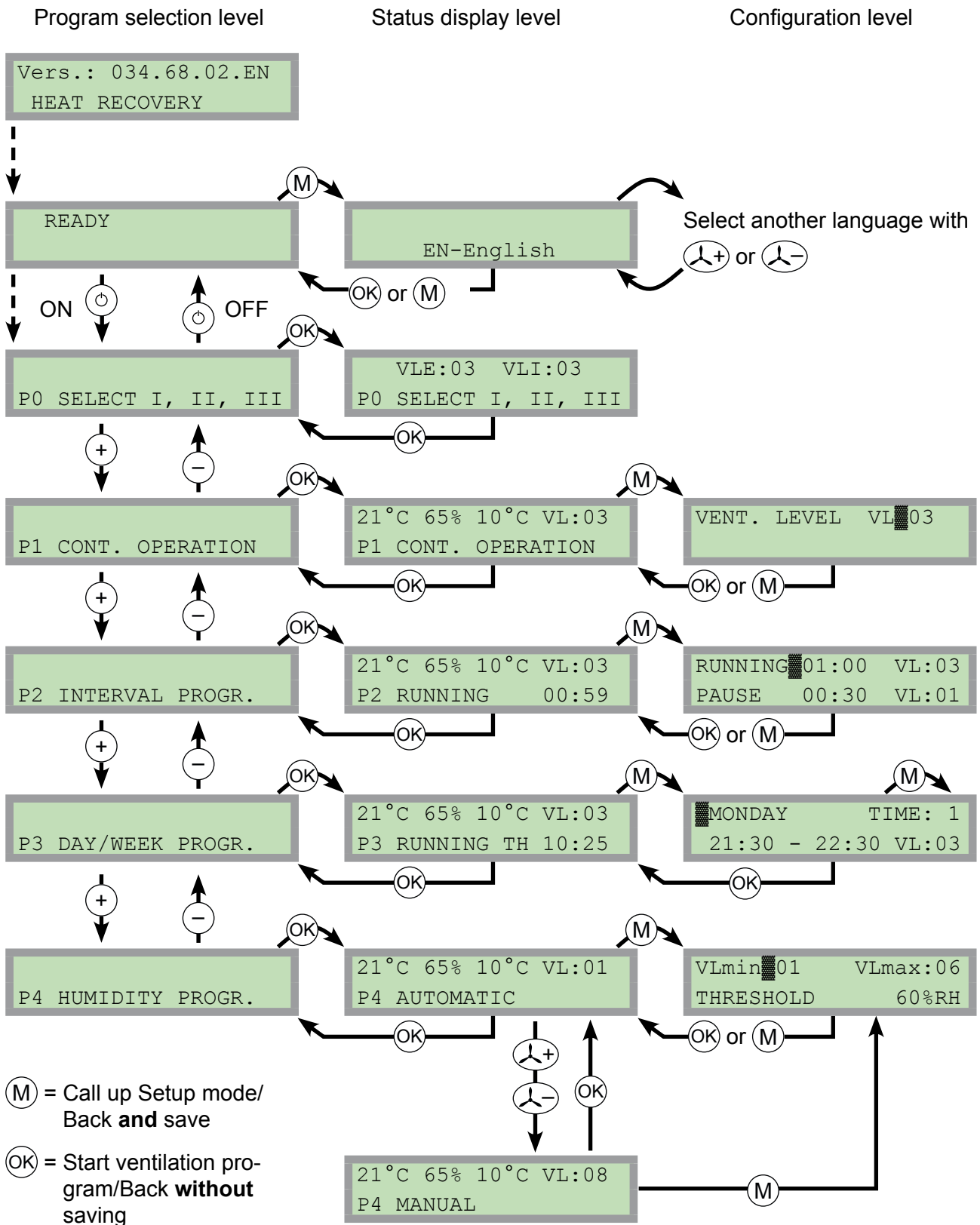

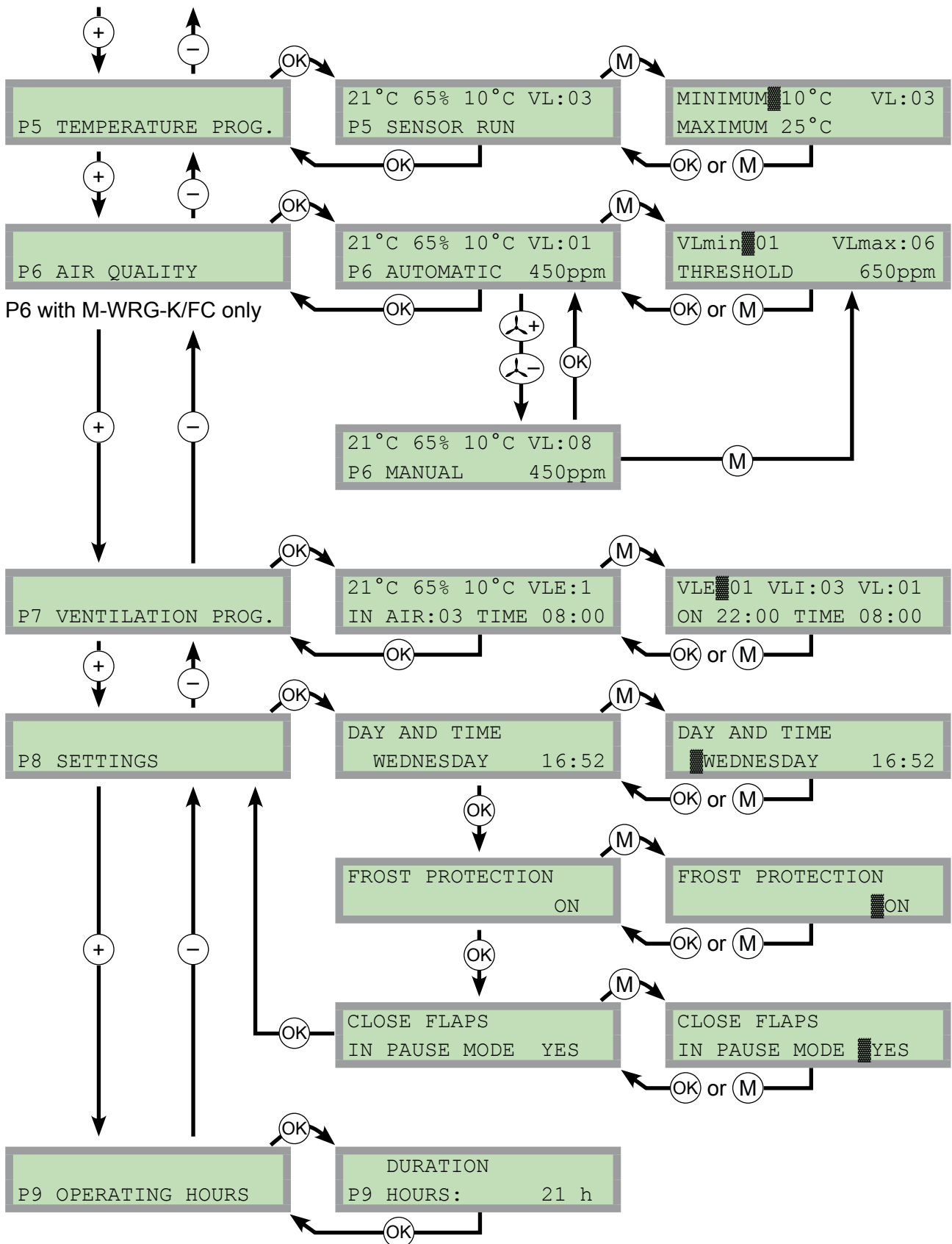



We have checked the content of this publication for conformity with the unit described in it. There may nevertheless still be differences, so we cannot guarantee complete accuracy.

The information in this publication is regularly checked and any necessary corrections are made in the subsequent editions.

Copyright © Meltem Wärmerückgewinnung GmbH & Co. KG

We reserve the right to make changes.

Meltem Wärmerückgewinnung GmbH & Co. KG

Am Hartholz 4
D-82239 Alling
Germany

Tel. +49 (0)8141 404179-0
Fax +49 (0)8141 404179-9
Internet: www.meltem.com
Email: info@meltem.com



Go to
Meltem download area