

HOME VENTILATION WITH HEAT RECOVERY

USER GUIDE

Wireless remote control M-WRG-FBH



Part no. 5302-25-01 Week 26/2020 EN



Contents

1	Introduction	5
1.1	Notes on the user guide	5
1.2	Description	5
1.3	Target group	6
1.4	EU declaration of conformity	6
1.5	Nameplate	6
1.6	Technical data	6
1.6.1	Electrical data	6
1.6.2	Dimensions and weight	6
1.6.3	Ambient conditions	6
1.7	Storage	6
1.8	Environmentally-friendly disposal	7
1.9	Revision index	7
1.10	Explanation of the symbols used	7
1.11	Supplementary documents	7
2	Safety instructions	8
2.1	Hazard classification	8
2.2	Notes on using the ventilation units safely	8
2.3	Notes on the batteries	8
2.4	Notes on using ventilation units with the wireless remote control	9
2.5	Intended use	9
3	Warranty and liability	10
3.1	Warranty	10
3.2	Liability	10
4	Items supplied	10
5	Controls and indicators	11
5.1	Buttons and LCD display	11
5.2	Symbols on the LCD display	12
6	Starting up	14
6.1	Insert batteries in wireless remote control	14
6.2	Establish connection between wireless remote control and ventilation unit	15
6.3	Disconnect connection between wireless remote control and ventilation unit	17
7	Display modes	19
7.1	Idle mode	19
7.2	Default view	19
7.3	Configure active ventilation program	19
7.4	Ventilation programs	20
7.5	Device settings	20
7.6	Manual mode	20
7.7	Connection mode	20

8	Overview of the ventilation programs	21
8.1	M-WRG-II ventilation programs	21
8.1.1	“Supply air operation (summer mode)”	21
8.1.2	“Extract air operation”	21
8.1.3	“Humidity control”	22
8.1.4	“CO ₂ control”	22
8.1.5	“Automatic mode”	23
8.1.6	“Continuous operation”	23
8.1.7	“Intensive ventilation (15 min)”	23
8.1.8	Device settings	23
8.2	M-WRG ventilation programs	24
8.2.1	“Supply air operation (summer mode)”	24
8.2.2	“Extract air operation”	24
8.2.3	“Humidity control”	25
8.2.4	“Mixed gas/CO ₂ control”	25
8.2.5	“Automatic mode”	26
8.2.6	“Continuous operation”	26
8.2.7	“Intensive ventilation (15 min)”	26
8.2.8	Device settings	26
9	Operating the ventilation unit with the wireless remote control M-WRG-FBH	27
9.1	Select ventilation program	27
9.1.1	Graphical illustration of the steps to select a ventilation program	27
9.2	Temporarily set ventilation levels in manual mode	28
9.2.1	Activate manual mode	28
9.2.2	Deactivate manual mode	28
9.2.3	Variable parameters in manual mode	29
9.3	Configure active ventilation program and permanently save settings	30
9.3.1	Configure and save parameters for active ventilation program	30
9.3.2	Graphical illustration of the steps to configure the active ventilation program	30
9.3.3	Overview of the variable parameters in the active ventilation program	31
9.4	Configure device settings	32
9.4.1	Configure and save parameters in Device settings menu	32
9.4.2	Graphical illustration of the steps in the Device settings menu	33
9.4.3	Variable parameters for ventilation units from the M-WRG-II series	34
9.4.4	Variable parameters for ventilation units from the M-WRG series	37
9.4.5	List of modes for ventilation units from the M-WRG-II and M-WRG series	40
10	Special functions	41
10.1	Standby mode	41
10.1.1	Set ventilation unit to Standby mode	41
10.1.2	Exit standby mode	42
10.2	Activate or deactivate intensive ventilation	42
10.3	Reset filter change indicator	42
11	Operation with multiple ventilation units	42
12	Troubleshooting	43



1 Introduction

1.1 Notes on the user guide



This user guide contains important information that should be followed when using the M-WRG-FBH wireless remote control.

- ▶ Read all the instructions carefully to avoid possible risks and mistakes.
- ▶ These instructions are part of the product. Keep the instructions in a safe place for future reference.

NOTICE

- ▶ When operating the ventilation unit, also follow the operating instructions that were supplied with your unit.

1.2 Description

This user guide describes how to set up and operate decentralised ventilation units from the M-WRG-II and M-WRG series constructed from 2018 onwards (excluding the -S 485, -S 485-TF, -S 485-TFC types) using the M-WRG-FBH wireless remote control (see Fig. 1).



Fig. 1: Ventilation units from the M-WRG-II and M-WRG series, M-WRG-FBH wireless remote control

The M-WRG-FBH wireless remote control has four buttons and an LCD display that provides information on the ventilation unit's current operating status. Up to six ventilation units of the same type can be controlled with one wireless remote control. The wireless remote control can be used to carry out the following actions:

- Establish and disconnect the connection between wireless remote control and ventilation unit
- Activate the ventilation unit or set it to Standby mode
- Select and configure the ventilation program
- Set device-specific parameters

1.3 Target group

This user guide is intended for users of the M-WRG-FBH wireless remote control. No special prior knowledge is needed.

1.4 EU declaration of conformity

The wireless remote control described below

Type:	Part number
M-WRG-FBH	5478-10

manufactured by

Meltem Wärmerückgewinnung GmbH & Co. KG
Am Hartholz 4
D-82239 Alling

conforms to the regulations and standards listed in the EU Declaration of Conformity.

1.5 Nameplate

You will find the nameplate on the inside of the battery compartment cover (see item 1 in Fig. 4 on page 14).

1.6 Technical data

1.6.1 Electrical data

Power supply	Two 1.5 V alkaline batteries, size AA
Communication frequency	868.3 MHz
Transmitter output power	Min. 0 dBm
IP rating to IEC 60529	IP20

1.6.2 Dimensions and weight

Unit dimensions	62.2 mm x 112.2 mm x 30 mm (W x H x D)
Weight without batteries	Approx. 77 g
Weight with two 1.5 V alkaline batteries	Approx. 123 g

1.6.3 Ambient conditions

Ambient temperature during operation	0 °C to +40 °C
Ambient temperature for shipping and storage	-20 °C to +50 °C
Relative humidity (non-condensing)	5 % to 90 %

1.7 Storage

- Store the wireless remote control in its original packaging in a dry place where the temperature ranges between -20 °C and +50 °C.

1.8 Environmentally-friendly disposal



The components of the wireless remote control must not be disposed of in the residual waste bin.

- ▶ In Germany, metal and plastic components should be disposed of at the local recycling centre. The national regulations in other EU states should also be followed.
- ▶ In Germany, electrical components should be disposed of in accordance with the Electrical and Electronic Equipment Act (ElektroG). In other EU states, the national implementation of the Waste Electrical and Electronic Equipment Directive 2012/19/EU (WEEE) should be followed.
- ▶ In Germany, rechargeable batteries and accumulators should be disposed of in accordance with the Batteries Act (BattG). The national implementation of the Battery Directive 2006/66/EC should be followed in other EU states.
- ▶ The regulations and statutory requirements in your own country concerning disposal should also be followed.

1.9 Revision index

Edition	Manual	Date
5th edition	User guide for wireless remote control M-WRG-FBH	Week 26/2020 EN

1.10 Explanation of the symbols used

- ▶ This symbol indicates an action to be taken.
- This symbol indicates a list.

1.11 Supplementary documents

Manual	Part no.
Operating instructions for M-WRG-II P (-F, -FC) and M-WRG-II E (-F, -FC) ventilation units	744007EN
Operating and installation instructions for M-WRG-II P-T (-F, -FC) and M-WRG-II E-T (-F, -FC) ventilation units	744008EN
Operating instructions for the M-WRG-S ventilation unit (standard unit)	5302-00-01
Operating instructions for M-WRG-S/Z-T (-F, -FC) ventilation unit	5302-22-01
Installation instructions and user guide for the 4-way wireless pushbutton switch M-WRG-FT	5301-14-01

Table 1: Supplementary documents

2 Safety instructions

This manual contains notes that you must follow for your own personal safety and to avoid injury and damage to property. They are highlighted by warning triangles and are shown as follows according to the level of danger.

2.1 Hazard classification

DANGER

The signal word designates a hazard with a **high** degree of risk which, if it is not avoided, will result in death or severe injury.

WARNING

The signal word designates a hazard with a **medium** degree of risk which, if it is not avoided, will result in death or severe injury.

CAUTION

The signal word designates a hazard with a **low** degree of risk which, if it is not avoided, could result in minor or moderate injury.

NOTICE

A note as used in this manual contains important information about the product or about a part of the manual to which particular attention should be paid.

2.2 Notes on using the ventilation units safely

- Do not start up the ventilation unit until it is fully installed.
- Always operate the ventilation unit with the air filters fitted.
- Always make sure that the cover is closed and locked in place before using the ventilation unit.
- Please note that the ventilation unit must not be used without the outer wall terminal for safety reasons.

2.3 Notes on the batteries

CAUTION

Risk of explosion if batteries are exposed to high temperatures

- ▶ Protect the batteries against high temperatures due to direct sunlight, for example.
- ▶ Never throw batteries into fire.
- ▶ Note the safety messages on the batteries.

2.4 Notes on using ventilation units with the wireless remote control

- This unit may be used by children from 8 years old and by persons of restricted physical, sensory or mental abilities or persons lacking experience and knowledge if they are supervised or have been instructed in how to use the unit safely and understand the associated hazards. Do not allow children to play with the unit. Cleaning and user maintenance must not be carried out by children unless they are supervised.
 - ▶ Follow the regulations applicable in your country concerning the age from which people may be permitted to operate the ventilation unit.

2.5 Intended use

- The wireless remote control must only be used to control and set the device-specific functions of the M-WRG-II and M-WRG ventilation units. Any different or more extensive usage will be regarded as contrary to the intended use.
- The intended use also includes compliance with all the notes in the user guide.
- The ventilation unit must not be operated without air filters or outer wall terminal.
- For any use contrary to the intended use, Meltem Wärmerückgewinnung GmbH & Co. KG shall accept no liability for any damage that may occur and offers no warranty that the ventilation unit will work perfectly and correctly.

3 Warranty and liability

3.1 Warranty

The following cases shall invalidate the warranty:

- The inner cover (see item 2 in Fig. 5 on page 14) with the battery compartment was removed.
- Repairs were not carried out by Meltem or by an authorised specialist company.
- The warranty does not cover wearing parts such as batteries.

3.2 Liability

The manufacturer's liability shall not apply in the following cases:

- The inner cover (see item 2 in Fig. 5 on page 14) with the battery compartment was removed.
- Repairs were not carried out by Meltem or by an authorised specialist company.

4 Items supplied

The M-WRG-FBH wireless remote control is supplied with the following items:

Item	Designation	Quantity
1	M-WRG-FBH wireless remote control	1x
2	1.5 V alkaline battery, size AA	2x
3	User guide for the M-WRG-FBH wireless remote control	1x

Table 2: Items supplied with the M-WRG-FBH wireless remote control

5 Controls and indicators

5.1 Buttons and LCD display

The M-WRG-FBH wireless remote control has four buttons and an LCD display that provides information on the operating status. The buttons perform multiple functions.

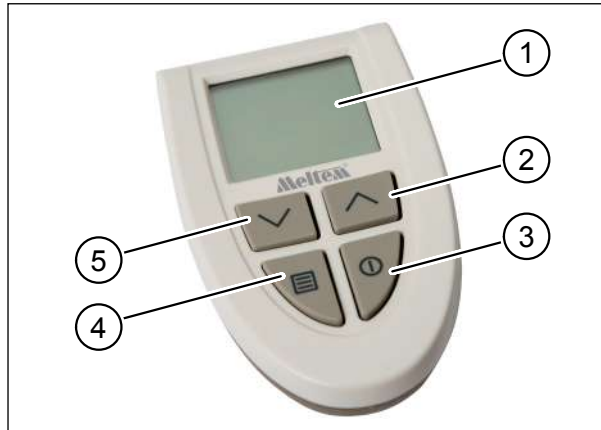

Fig. 2: Controls and indicators





Item	Element	Symbol	Function
1	LCD display	-	Displays the current menu
2	“Up” button		<ul style="list-style-type: none"> — Increase value — Select next menu option — Activate LCD display — Exit manual mode — Activate / deactivate intensive ventilation
3	“On” button		<ul style="list-style-type: none"> — Call up menu with ventilation programs — Activate LCD display — Activate / deactivate Standby mode — Return to previous menu
4	“Menu” button		<ul style="list-style-type: none"> — Call up Configuration menu for active ventilation program — Call up next item from the Configuration menu — Activate LCD display — Connect or disconnect remote control from ventilation unit — Reset filter change indicator
5	“Down” button		<ul style="list-style-type: none"> — Reduce value — Select previous menu item — Activate LCD display — Exit manual mode

Table 3: Buttons and LCD display

5.2 Symbols on the LCD display

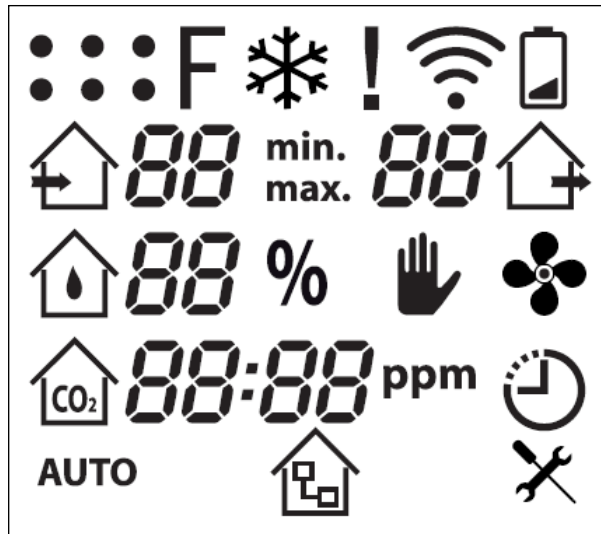

Fig. 3: Symbols on the LCD display

Symbol	Name	Description
⋮	Ventilation units	One dot is displayed for every ventilation unit that is connected (up to 6). The flashing dot corresponds to the ventilation unit with which communication is currently active.
F	Filter	<ul style="list-style-type: none"> — The symbol is displayed continuously if the air filter is dirty (see section 12 on page 43). — The symbol flashes if the one-year filter change interval is exceeded (see section 12 on page 43).
❄️	Frost protection	The symbol appears when the frost protection function is active.
!	Exclamation mark	The symbol appears when the ventilation unit signals an error (see section 12 on page 43).
📶	RF communication	The symbol appears when the remote control is connected to a ventilation unit and when communication is in progress with that ventilation unit.
🔋	Battery	The symbol appears when the batteries in the wireless remote control are almost flat and need to be changed (see section 6.1 on page 14).
🏠	Supply air	<ul style="list-style-type: none"> — Symbol for the “Supply air operation (Summer mode)” ventilation program. Flashes when activated. — The value beside the symbol indicates the current supply air ventilation level in all ventilation programs. For ventilation units from the M-WRG-II series, ventilation levels with values between 10 and 99 are displayed. For ventilation units from the M-WRG series, ventilation levels with values between 1 and 10 are displayed.
min. max.	Min/Max	The symbol indicates whether a value is a minimum or maximum.











Symbol	Name	Description
	Extract air	<ul style="list-style-type: none"> — Symbol for the “Extract air operation” ventilation program. Flashes when activated. — The value beside the symbol indicates the current extract air ventilation level in all ventilation programs. For ventilation units from the M-WRG-II series, ventilation levels with values between 10 and 99 are displayed. For ventilation units from the M-WRG series, ventilation levels with values between 1 and 10 are displayed.
	Relative humidity (RH)	<ul style="list-style-type: none"> — Symbol for the “Humidity control” ventilation program. Flashes when activated. — The symbol and value for the relative humidity appear continuously in every ventilation program if the ventilation unit is equipped with a humidity sensor.
	Percent	The symbol and two-digit value for the relative humidity appear continuously in every ventilation program if the ventilation unit is equipped with a humidity sensor.
	Manual mode	The symbol appears when the user manually changes the value calculated or set for the ventilation level. The changes are not stored permanently.
	Continuous operation	Symbol for the “Continuous operation” ventilation program. Flashes when activated.
	Mixed gas/CO ₂	<ul style="list-style-type: none"> — Symbol for the “Mixed gas/CO₂ control” ventilation program. Flashes when activated. — The symbol and value for the mixed gas/CO₂ concentration appear continuously in every ventilation program if the ventilation unit is equipped with a mixed gas/CO₂ sensor.
	ppm	The symbol and four-digit value for the mixed gas/CO ₂ concentration appear continuously in every ventilation program if the ventilation unit is equipped with a mixed gas/CO ₂ sensor.
	Intensive ventilation	Symbol for the “Intensive ventilation” program. Flashes when activated.
	Automatic mode	Symbol for the “Automatic mode” ventilation program. Flashes when activated.
	Gateway	The symbol appears when the ventilation unit is controlled via a gateway or there is an active ventilation program that is not supported by the wireless remote control.
	Device settings	Symbol for the Device settings menu. This is used to read, configure and permanently store device-specific settings.

Table 4: Symbols on the LCD display

6 Starting up

6.1 Insert batteries in wireless remote control

- ▶ Remove the cover (item 1 in Fig. 4) from the battery compartment on the back of the wireless remote control. To do this, pull the cover down as far as it will go, then lift off.
- ▶ Insert the batteries supplied in the battery compartment.

NOTICE

Make sure that the polarity symbols on the batteries match the polarity symbols in the battery compartment. The wireless remote control may be damaged if the batteries are wrongly inserted.

The wireless remote control initialises when the batteries are inserted. The following information appears on the LCD display:

- First all available symbols are displayed (see Fig. 3 on page 12).
 - Then the wireless remote control's software version is displayed, e.g. "r001".
 - This is followed by the default view (see section 7.2 on page 19).
- ▶ Attach the cover to close the battery compartment.

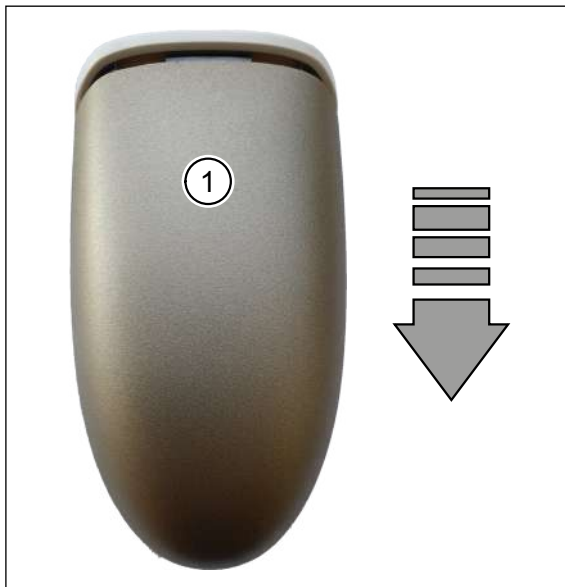

Fig. 4: Remove battery compartment cover



Fig. 5: Insert batteries in battery compartment

6.2 Establish connection between wireless remote control and ventilation unit

- ▶ Switch the ventilation unit on.

NOTICE

- When the ventilation unit is switched on, it remains in connection mode for 5 minutes. The connection between wireless remote control and ventilation unit can only be established during this period.
- If there are multiple ventilation units within the wireless remote control's transmission range, we recommend that you only switch on the ventilation unit to which you want to connect.

- ▶ Press any button on the wireless remote control to activate the LCD display on the wireless remote control and switch to the default view (see section 7.2 on page 19). If there is no ventilation unit yet connected, the LCD display contains the following information:



Fig. 6: Default view (no ventilation unit connected)



- ▶ Hold down button  and  at the same time for more than 3 seconds to call up the menu for connecting/disconnecting a ventilation unit.
 - If there is no ventilation unit yet connected, the LCD display contains the following information:



Fig. 7: Connection menu (no ventilation unit connected)

- If there are already ventilation units connected, the LCD display shows the number of connected ventilation units both as a number and in the form of dots (4 in this example):



Fig. 8: Connection menu (4 ventilation units already connected)

- ▶ Hold down the  button for more than 3 seconds to connect a new ventilation unit. The LCD display shows the following information:

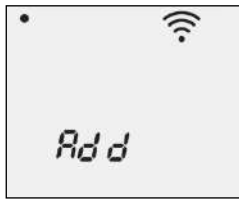



Fig. 9: Connect new ventilation unit

The dot in the top left corner flashes to indicate that ventilation unit 1 can be connected.

- ▶ Press the  button to establish the connection between wireless remote control and ventilation unit.

While the connection to the ventilation unit is initialising, the ventilation unit beeps and the LCD display on the wireless remote control shows the following information:

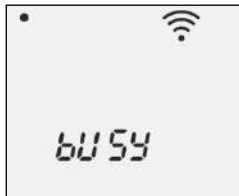

Fig. 10: Initialise connection set-up

The dot representing the ventilation unit and the  symbol flash.

- Once the connection has been established successfully, the LCD display shows the following information:



Fig. 11: Connection successfully established

The dot representing the ventilation unit and the  symbol flash.

- If no connection could be established, the LCD display shows the following information:

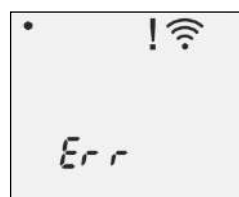





Fig. 12: Connection not successfully established

The dot representing the ventilation unit flashes. The  and  symbols are displayed.



When the  or  button is pressed or after 3 seconds, the Connection menu appears (see Fig. 7 on page 15).

6.3 Disconnect connection between wireless remote control and ventilation unit

- ▶ Switch the ventilation unit on.

NOTICE

- When the ventilation unit is switched on, it remains in connection mode for 5 minutes. The connection between wireless remote control and ventilation unit can only be disconnected during this period.
- If there are multiple ventilation units within the wireless remote control's transmission range, we recommend that you only switch on the ventilation unit from which you want to disconnect.

- ▶ Press any button on the wireless remote control to activate the LCD display on the wireless remote control and switch to the default view (see section 7.2 on page 19).
- ▶ Hold down button  and  at the same time for more than 3 seconds to call up the menu for connecting/disconnecting a ventilation unit.

The LCD display shows the number of connected ventilation units both as a number and in the form of dots (2 in this example):

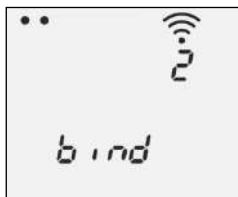



Fig. 13: Connection menu (2 ventilation units already connected)



- ▶ Hold down the  button for more than 3 seconds to disconnect a connection between wireless remote control and ventilation unit.

The LCD display shows the following information:





Fig. 14: Disconnect connection to ventilation unit

The number of the currently selected ventilation unit is displayed and the corresponding dot flashes.

- ▶ Use the  or  button to select the ventilation unit for which you want to disconnect the connection.

NOTICE

Hold down the  button for more than 3 seconds to activate the buzzer on the currently selected ventilation unit. This will allow you to check that you have selected the right ventilation unit and that it is within range.

- ▶ Press the  button to disconnect the connection between wireless remote control and ventilation unit.

While the connection to the ventilation unit is initialising, the ventilation unit beeps and the LCD display on the wireless remote control shows the following information:



Fig. 15: Initialise connection set-up

The dot representing the ventilation unit and the  symbol flash.

- Once the connection has been successfully disconnected, the LCD display shows the following information:



Fig. 16: Connection successfully disconnected

The dot representing the ventilation unit and the  symbol flash.

- If no connection could be established, the LCD display shows the following information:

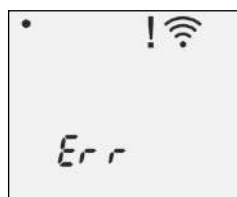





Fig. 17: Connection not successfully disconnected

The dot representing the ventilation unit flashes. The  and  symbols are displayed.

When the  or  button is pressed or after 3 seconds, the Connection menu appears (see Fig. 13 on page 17).

7 Display modes

7.1 Idle mode

The LCD display switches off after 20 seconds inactivity. Press any button to switch the wireless remote control from idle mode to the default view.

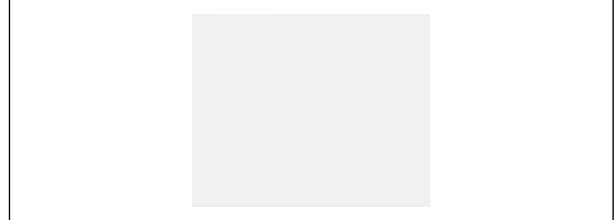

Fig. 18: Display mode – idle mode

7.2 Default view

The default view displays the currently selected ventilation program. The wireless remote control also checks the operating parameters (e.g. ventilation level for supply air and extract air, relative humidity, etc.) and shows them on the LCD display (see Table 4 on page 13 for an explanation of the symbols). Which operating parameters are displayed depends on the currently selected ventilation program and the ventilation unit features (humidity sensor, mixed gas/CO₂ sensor). The dot representing the selected ventilation unit and the symbol for the active ventilation program flash.

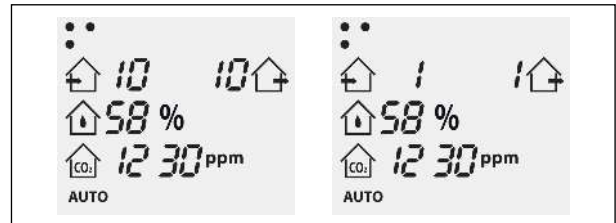



Fig. 19: M-WRG-II / M-WRG display mode: default view

7.3 Configure active ventilation program

Press the  button in the default view to open the menu for configuring the active ventilation program. Here you can read, configure and permanently store the most important parameters (ventilation levels, thresholds) for the active ventilation program (see section 9.3 on page 30).

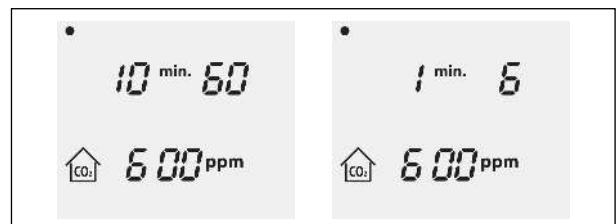



Fig. 20: M-WRG-II / M-WRG display mode: configure active ventilation program

7.4 Ventilation programs

Press the  button in the default view to open the menu for selecting the ventilation programs. Which ventilation programs are displayed depends on the ventilation unit features (humidity sensor, mixed gas/CO₂ sensor, there is an explanation of the symbols used in Table 4 from page 12). The symbol for the active ventilation program flashes.

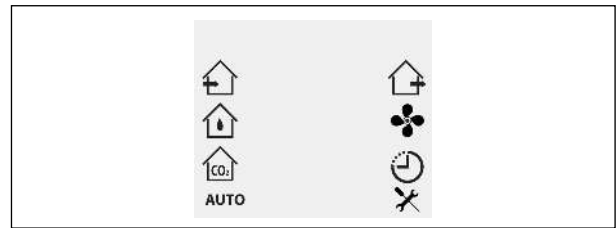

Fig. 21: Display mode – Ventilation programs

7.5 Device settings





Select the  symbol in the ventilation programs display mode to open the Device settings menu. Here you can read, configure and permanently store the ventilation program parameters and device-specific settings (see section 9.4 on page 32).



Fig. 22: Display mode – Device settings

7.6 Manual mode

Press the  or  button in the default view to temporarily increase or reduce the ventilation level. The ventilation level of the extract air, supply air or both is changed according to the active ventilation program.

The  symbol signals that manual mode is active (see section 9.2 on page 28).

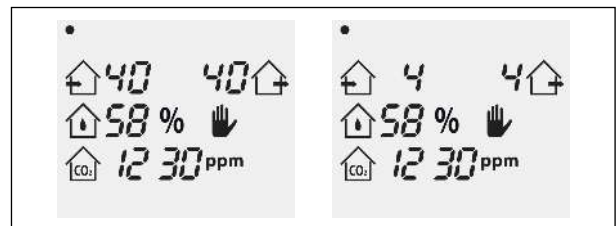

Fig. 23: M-WRG-II / M-WRG display mode: manual mode

7.7 Connection mode



Hold down the  and  buttons at the same time in the default view and for longer than 3 seconds to open the Connection mode display (see also section 6.2 on page 15).



Fig. 24: Display mode – Connection mode

8 Overview of the ventilation programs

There are different ventilation programs available for selection, depending on the type of ventilation unit. The ventilation unit informs the wireless remote control which ventilation programs it supports.



The individual ventilation programs are identified by symbols (see section 7.4 on page 20) on the LCD display. The symbol for the active ventilation program and the dot representing the selected ventilation unit flash. The description of the individual ventilation programs relates to the factory default settings.

8.1 M-WRG-II ventilation programs



NOTICE

For ventilation units from the M-WRG-II series, the ventilation level and volumetric flow rate are related as follows: ventilation level 10 corresponds to 10 m³/h, ventilation level 20 corresponds to 20 m³/h, ..., ventilation level 90 corresponds to 90 m³/h and ventilation level 99 corresponds to 100 m³/h.

8.1.1 “Supply air operation (summer mode)”

Symbol	Default view	Description
		<p>The ventilation unit only transports supply air; the extract air is switched off. This operating mode allows the cooler outdoor air to be routed into the building on summer nights, for example (supply air 50 m³/h, extract air 0 m³/h).</p> <p>NOTICE</p> <p>Avoid using this ventilation program at cold times of year. Otherwise the ventilation unit will constantly activate the frost protection function or switch off altogether.</p>

8.1.2 “Extract air operation”

Symbol	Default view	Description
		<p>The ventilation unit only transports extract air; the supply air is switched off. This operating mode can be selected to route used air to the outside (extract air 50 m³/h, supply air 0 m³/h).</p> <p>Cross-ventilation: If there are two ventilation units present, cross-ventilation can be achieved on one level by setting one ventilation unit to supply air operation and the other to exhaust air operation.</p> <p>NOTICE</p> <p>Avoid using cross-ventilation at cold times of year, otherwise the ventilation unit that is set to supply air operation will constantly activate the frost protection function or switch off altogether.</p>

8.1.3 “Humidity control”

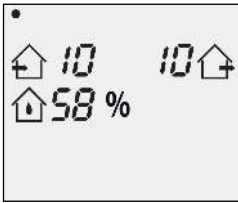
Symbol	Default view	Description
		<p>The ventilation unit runs constantly at the lowest ventilation level (10 m³/h*). If the relative room air humidity exceeds 60 % RH, the ventilation level is increased continuously up to max. 60 m³/h until the humidity in the room drops back below 60% RH.</p> <p>NOTICE</p> <p>To ensure dehumidification, the ventilation unit compares the calculated absolute humidity of the supply air and extract air. LED 3 on the M-WRG-II ventilation unit flashes when the humidity of the outdoor air is greater than that of the extract air, which means that dehumidification is not possible.</p>

8.1.4 “CO₂ control”

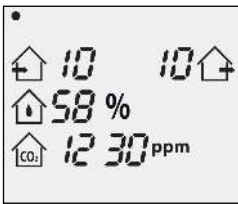

Symbol	Default view	Description
		<p>The ventilation unit runs constantly at the lowest ventilation level (10 m³/h*). A CO₂ sensor monitors the air quality in the room. If the limit of 800 ppm is exceeded, the ventilation unit calculates the optimum air renewal and sets the required ventilation level in the range from 10 - 60 m³/h.</p> <p>If equipped with the M-WRG-II O/VOC-AUL option, ventilation units with a CO₂ sensor can also detect volatile organic compounds in the outdoor air using a VOC sensor.</p> <p>NOTICE</p> <ul style="list-style-type: none"> — When it is started up for the first time, the ventilation unit must remain switched on for at least 15 minutes without interruption so that the VOC sensor can be calibrated. <ul style="list-style-type: none"> ▶ Make sure that the air is not severely contaminated during the calibration phase by solvents, for example. — When you switch on again, it will take roughly 5 minutes for the sensor to recalibrate.

* The ventilation level can be reduced from 10 to 0 m³/h at the factory or using the optional wireless remote control M-WRG-FBH. The ventilation unit switches to sniffing mode and interrupts its operation for the set pause time (set to 60 minutes at the factory). The relative humidity or CO₂ concentration is then checked for a 5-minute period. If the corresponding limit is exceeded, the ventilation unit switches back to ventilation mode.

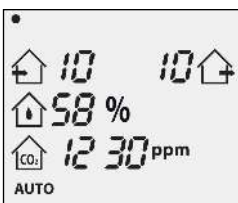



8.1.5 “Automatic mode”

Symbol	Default view	Description
AUTO		The relative room air humidity (see section 8.1.4 on page 22) is monitored in addition to the CO ₂ concentration (see section 8.1.3 on page 22). The CO ₂ sensor and the humidity sensor both send feedback to the ventilation unit, indicating the ventilation level at which it should work. The ventilation unit automatically assumes the higher of the two suggested ventilation levels and thus ensures the priority.

8.1.6 “Continuous operation”

Symbol	Default view	Description
		The ventilation unit runs in continuous operation. By default, ventilation level 30 (30 m ³ /h) is set for supply air and extract air.

8.1.7 “Intensive ventilation (15 min)”

Symbol	Default view	Description
		<p>The ventilation unit runs at maximum ventilation level (100 m³/h). After 15 minutes (factory default setting), the previously set ventilation program is resumed.</p> <p>Hold down the  button for more than 3 seconds to activate or deactivate intensive ventilation.</p> <p>Press the  or  button to adjust the ventilation level temporarily while intensive ventilation is running. The default setting will be resumed when intensive ventilation is used again.</p>

8.1.8 Device settings

Symbol	Default view	Description
	-	This menu is used to read, configure and permanently store the ventilation program parameters and device-specific settings.

8.2 M-WRG ventilation programs

NOTICE

For ventilation units from the M-WRG series, the ventilation level and volumetric flow rate are related as follows: ventilation level 1 corresponds to 15 m³/h, ventilation level 2 corresponds to 20 m³/h, ..., ventilation level 9 corresponds to 90 m³/h and ventilation level 10 corresponds to 100 m³/h.

8.2.1 “Supply air operation (summer mode)”

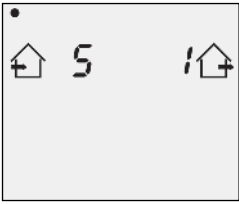
Symbol	Default view	Description
		<p>The ventilation unit runs in supply air operation with limited heat recovery. This operating mode allows the cooler outdoor air to be routed into the building on summer nights, for example (supply air 50 m³/h, extract air 15 m³/h).</p> <p>NOTICE</p> <p>Avoid using this ventilation program at cold times of year. Otherwise the ventilation unit will constantly activate the frost protection function or switch off altogether.</p>

8.2.2 “Extract air operation”

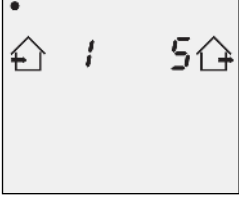
Symbol	Default view	Description
		<p>The ventilation unit runs in extract air operation with limited heat recovery. This operating mode can be selected to route used air to the outside (extract air 50 m³/h, supply air 15 m³/h).</p> <p>Cross-ventilation: If there are two ventilation units present, cross-ventilation can be achieved on one level by setting one ventilation unit to supply air operation and the other to exhaust air operation.</p> <p>NOTICE</p> <p>Avoid using cross-ventilation at cold times of year, otherwise the ventilation unit that is set to supply air operation will constantly activate the frost protection function or switch off altogether.</p>

8.2.3 “Humidity control”

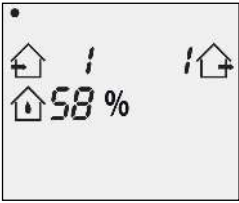
Symbol	Default view	Description
		<p>The ventilation unit runs constantly at the lowest ventilation level (15 m³/h*). If the relative room air humidity exceeds 60 % RH, the ventilation level is increased continuously up to max. 60 m³/h until the humidity in the room drops back below 60% RH.</p> <p>NOTICE</p> <p>To ensure dehumidification, the ventilation unit compares the humidity of the supply air and extract air. The ventilation unit ventilates at the lowest level when the humidity of the supply air is greater than that of the extract air, which means that dehumidification is not possible.</p>

8.2.4 “Mixed gas/CO₂ control”

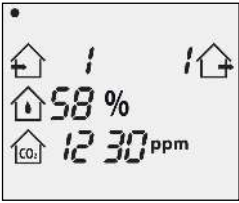
Symbol	Default view	Description
		<p>The ventilation unit runs constantly at the lowest ventilation level (15 m³/h*). A sensor monitors the air quality in the room (CO₂ and various pollutants in gaseous form). If the limit of 600 ppm is exceeded, the ventilation unit calculates the optimum air renewal and sets the required ventilation level in the range from 15 - 60 m³/h fully automatically.</p> <p>NOTICE</p> <ul style="list-style-type: none"> — When it is started up for the first time, the ventilation unit must remain switched on for at least 15 minutes without interruption so that the VOC sensor can be calibrated. <ul style="list-style-type: none"> ▶ Make sure that the air is not severely contaminated during the calibration phase by solvents, for example. — When you switch on again, it will take roughly 5 minutes for the sensor to recalibrate.

* The ventilation level can be reduced from 15 to 0 m³/h at the factory or using the optional wireless remote control M-WRG-FBH. The ventilation unit switches to sniffing mode and interrupts its operation for the set pause time (set to 60 minutes at the factory). The relative humidity or mixed gas/CO₂ concentration is then checked for a 5-minute period. If the corresponding limit is exceeded, the ventilation unit switches back to ventilation mode.



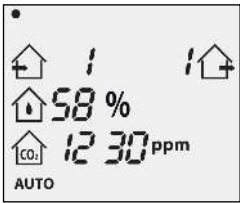

8.2.5 “Automatic mode”

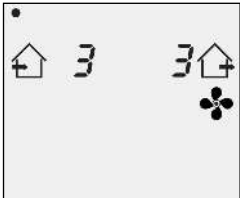
Symbol	Default view	Description
AUTO		<p>This ventilation program combines the “Humidity control” (see section 8.2.3 on page 25,) and “Mixed gas/CO₂ control” (see section 8.2.4 on page 25) ventilation programs. In automatic mode, the relative room air humidity is monitored in addition to the mixed gas/CO₂ concentration. The mixed gas/CO₂ sensor and the humidity sensor each send feedback to the ventilation unit, indicating the ventilation level at which it should work. The ventilation unit automatically assumes the higher of the two suggested ventilation levels and thus ensures the priority.</p> <p>NOTICE</p> <p>► Note the information on calibrating the mixed gas/CO₂ sensor in section 8.2.4 on page 25.</p>

8.2.6 “Continuous operation”

Symbol	Default view	Description
		<p>The ventilation unit runs in continuous operation. By default, ventilation level 3 (30 m³/h) is set for supply air and extract air.</p>

8.2.7 “Intensive ventilation (15 min)”



Symbol	Default view	Description
		<p>The ventilation unit runs at maximum ventilation level (100 m³/h). After 15 minutes (factory default setting), the previously set ventilation program is resumed.</p> <p>Hold down the  button for more than 3 seconds to activate or deactivate intensive ventilation.</p> <p>Press the  or  button to adjust the ventilation level temporarily while intensive ventilation is running. The default setting will be resumed when intensive ventilation is used again.</p>

8.2.8 Device settings

Symbol	Default view	Description
	-	<p>This menu is used to read, configure and permanently store the ventilation program parameters and device-specific settings.</p>

9 Operating the ventilation unit with the wireless remote control M-WRG-FBH

9.1 Select ventilation program

- ▶ Press any button on the wireless remote control to switch from idle mode (see section 7.1 on page 19) to the default view (see section 7.2 on page 19).
- ▶ Press the  button to switch from the default view to the menu for selecting the ventilation programs.
- ▶ Use the  or  button to select the desired ventilation program. The symbol for the currently selected ventilation program flashes.

The order of the ventilation programs is as follows:

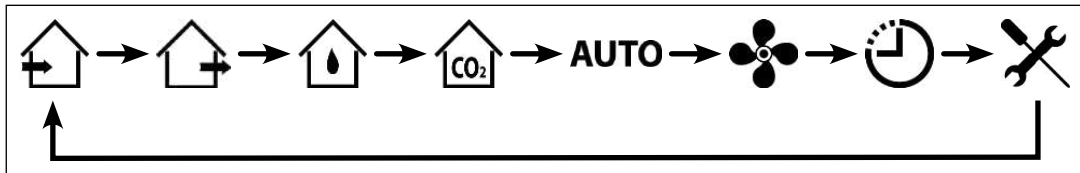



Fig. 25: Order of the ventilation programs

- ▶ Press the  button to confirm your selected ventilation program or wait 5 seconds until the ventilation program is activated automatically.

9.1.1 Graphical illustration of the steps to select a ventilation program

Fig. 26 summarises the steps to select a ventilation program.

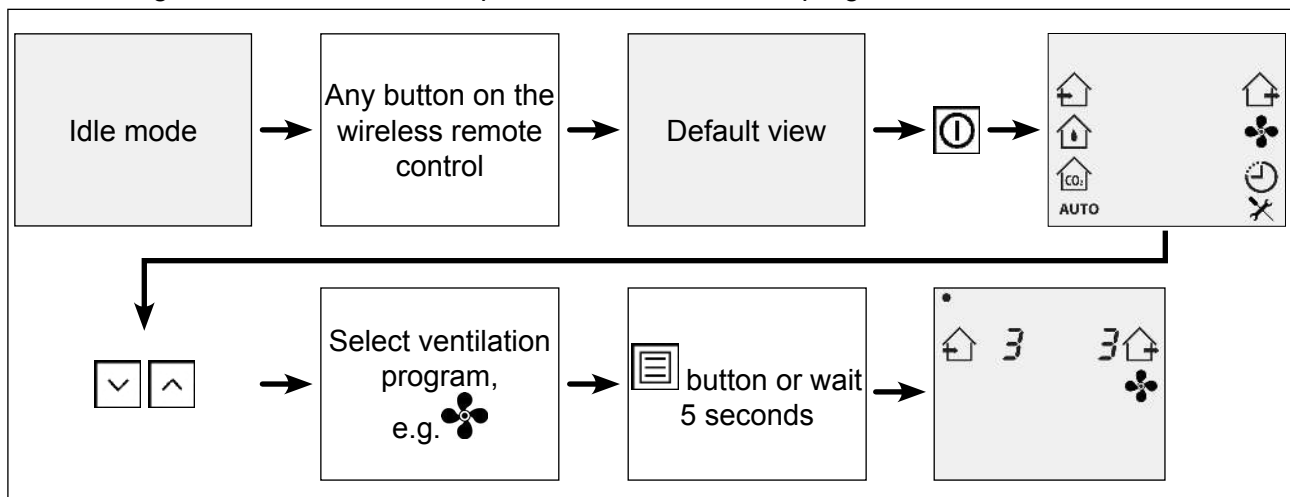





Fig. 26: Select ventilation program with wireless remote control (e.g. continuous operation)

9.2 Temporarily set ventilation levels in manual mode

If necessary, you can temporarily change the ventilation levels of the active ventilation program. These manually set values for the ventilation levels are not stored permanently, however, and will be lost when you change the ventilation program.



9.2.1 Activate manual mode

- ▶ Press any button on the wireless remote control to switch from idle mode (see section 7.1 on page 19) to the default view (see section 7.2 on page 19).
- ▶ In the default view, press the  or  button to reduce or increase the ventilation level(s) of the active ventilation program. The ventilation level of the extract air, supply air or both is changed according to the active ventilation program (see Table 5 on page 29).

The  symbol appears on the LCD display. This signals that Manual mode is active.

- ▶ Wait for more than 3 seconds to accept the new values for the ventilation levels and return to the default view.

9.2.2 Deactivate manual mode

- ▶ In the default view, press the  or  button to deactivate manual mode.

The  symbol disappears and the ventilation unit resumes ventilation with the ventilation levels that were preset or specified by the sensors.

9.2.3 Variable parameters in manual mode





Manual mode*	Ventilation program	Variable parameters	Description
	Supply air operation	— Ventilation level for supply air	Ventilation level for supply air flashes.
	Extract air operation	— Ventilation level for extract air	Ventilation level for extract air flashes.
	Humidity control	— Ventilation level for supply air — Ventilation level for extract air	The two ventilation levels flash at the same time and are set at the same time.
	Mixed gas/CO ₂ control	— Ventilation level for supply air — Ventilation level for extract air	The two ventilation levels flash at the same time and are set at the same time.
	Automatic mode	— Ventilation level for supply air — Ventilation level for extract air	The two ventilation levels flash at the same time and are set at the same time.
	Continuous operation	— Ventilation level for supply air — Ventilation level for extract air	The two ventilation levels flash at the same time and are set at the same time.
	Intensive ventilation	— Ventilation level for supply air — Ventilation level for extract air	The two ventilation levels flash at the same time and are set at the same time.

Table 5: Temporarily set ventilation levels in manual mode



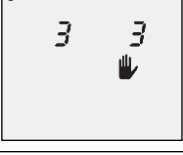
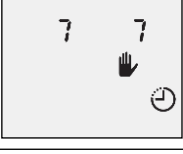

* For ventilation units from the **M-WRG-II** series, ventilation levels with values between **10 and 99** are displayed. For ventilation units from the **M-WRG** series, ventilation levels with values between **1 and 10** are displayed.

9.3 Configure active ventilation program and permanently save settings

In the default view you can configure and permanently store the most important parameters (ventilation levels, thresholds) for the active ventilation program (see Table 6 on page 31).

More extensive settings and other device-specific functions can be read, configured and stored in the Device settings menu (see section 9.4 on page 32).

9.3.1 Configure and save parameters for active ventilation program

- ▶ Press any button on the wireless remote control to switch from idle mode (see section 7.1 on page 19) to the default view (see section 7.2 on page 19).
- ▶ In the default view, press the  button to open the configuration menu for the active ventilation program.
The first parameter to be set flashes.
- ▶ Press the  or  button to reduce or increase the value of the current parameter.
- ▶ Press the  button to move to the next parameter.
- ▶ Set the configurable parameters to suit your needs (see Table 6 on page 31).
- ▶ Press the  button to permanently save the parameters and return to the default view.

9.3.2 Graphical illustration of the steps to configure the active ventilation program

Fig. 27 summarises the steps to configure the active ventilation program (e.g. mixed gas/CO₂ program).

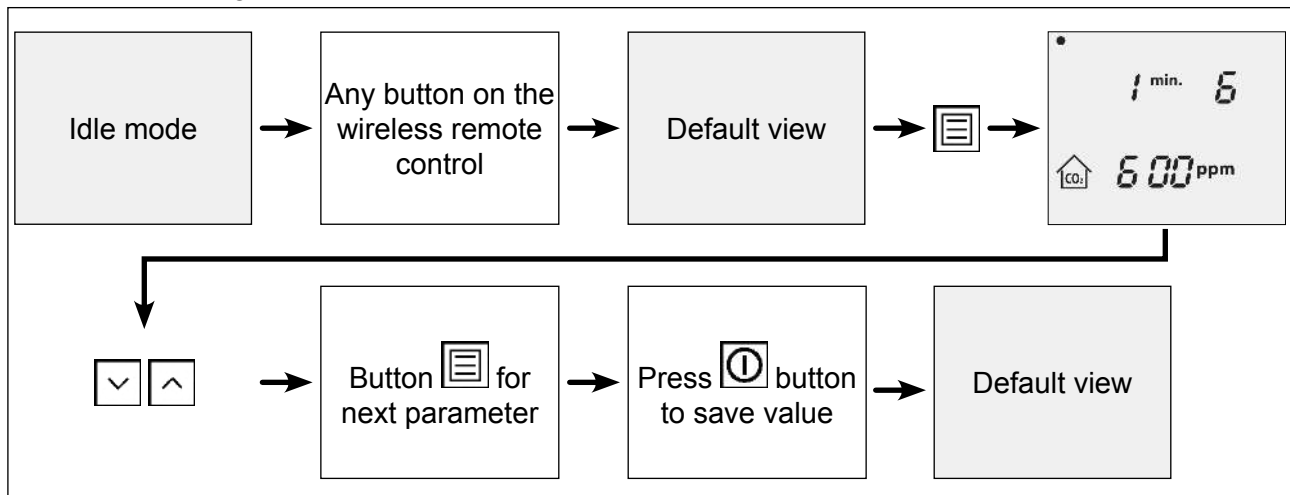

Fig. 27: Configure and permanently save active ventilation program (e.g. mixed gas/CO₂ program)

9.3.3 Overview of the variable parameters in the active ventilation program









Configuration menu*	Ventilation program	Variable parameters	Description
	Supply air operation	<ul style="list-style-type: none"> — Ventilation level for supply air — Ventilation level for extract air 	The first parameter flashes. The two parameters can be set individually.
	Extract air operation	<ul style="list-style-type: none"> — Ventilation level for supply air — Ventilation level for extract air 	The first parameter flashes. The two parameters can be set individually.
	Humidity control	<ul style="list-style-type: none"> — Min. ventilation level — Max. ventilation level — Threshold for humidity 	The first parameter flashes. All the parameters can be set individually.
	Mixed gas/CO ₂ control	<ul style="list-style-type: none"> — Min. ventilation level — Max. ventilation level — Threshold for mixed gas/CO₂ 	The first parameter flashes. All the parameters can be set individually.
 	Automatic mode	<ul style="list-style-type: none"> — Min. ventilation level for humidity control — Max. ventilation level for humidity control — Threshold for humidity — Min. ventilation level for mixed gas/CO₂ — Max. ventilation level for mixed gas/CO₂ — Threshold for mixed gas/CO₂ 	The first parameter flashes. All the parameters can be set individually.
	Continuous operation	<ul style="list-style-type: none"> — Ventilation level for supply air — Ventilation level for extract air 	The parameters flash at the same time and are set at the same time.
	Intensive ventilation	<ul style="list-style-type: none"> — Ventilation level for supply air — Ventilation level for extract air 	The parameters flash at the same time and are set at the same time.

Table 6: Overview of the variable parameters in the active ventilation program

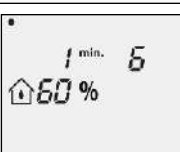













* For ventilation units from the **M-WRG-II** series, ventilation levels with values between **10 and 99** are displayed. For ventilation units from the **M-WRG** series, ventilation levels with values between **1 and 10** are displayed.

9.4 Configure device settings

The Device settings menu is used to read, configure and permanently store the ventilation program parameters and device-specific settings.

This menu provides the most extensive set of settings for adapting the ventilation programs and device-specific parameters to your own needs. A unique code is assigned to each parameter (see section 9.4.3 from page 34 or section 9.4.4 from page 37).

9.4.1 Configure and save parameters in Device settings menu

- ▶ Press any button on the wireless remote control to switch from idle mode (see section 7.1 on page 19) to the default view (see section 7.2 on page 19).
- ▶ Press the  button to switch from the default view to the menu for selecting the ventilation programs.
- ▶ Press the  or  button until the  symbol for the device settings flashes.
- ▶ Press the  button to confirm your selection or wait 5 seconds until the Device settings menu opens.
- ▶ Use the  or  button to select the parameter that you want to configure (see Table 7 on page 37 or Table 8 on page 40).
- ▶ Press the  button to confirm your selection.
- ▶ Use the  or  button to select the value that you want for the parameter.
- ▶ Press the  button to confirm the value.
- ▶ Use the  or  button to select the next parameter that you want to configure.
- ▶ Press the  button to exit the configuration and return to the default view. After 1 minute of inactivity, the default view is displayed automatically.

9.4.2 Graphical illustration of the steps in the Device settings menu

Fig. 28 summarises the steps to adapt the parameters in the Device settings menu.

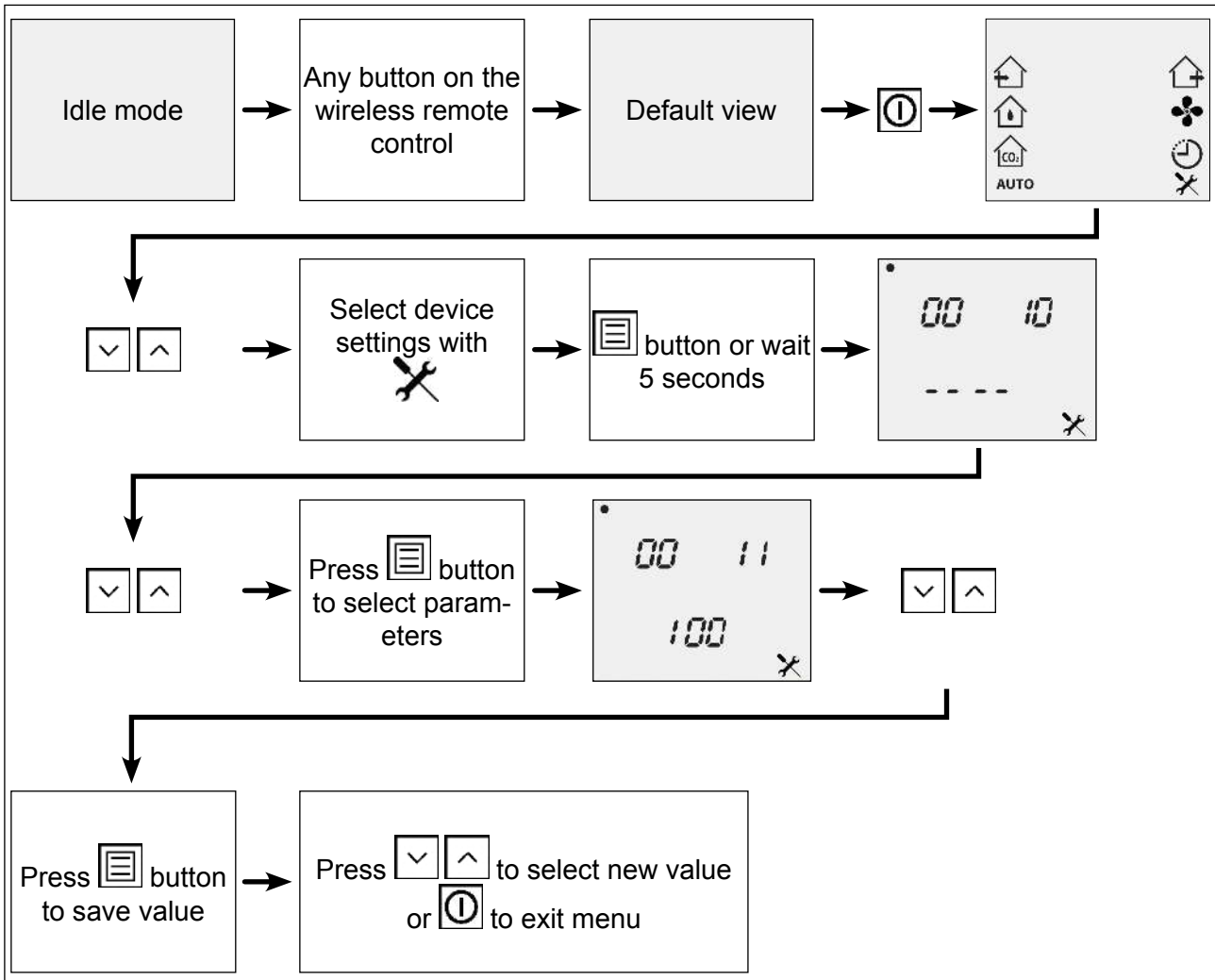

Fig. 28: Changing parameters in the Device settings menu

9.4.3 Variable parameters for ventilation units from the M-WRG-II series

Code	Parameter	Min.	Max.	Increment	Default	Unit	Comment
84	Fan motors operating hours						Running time of the fan motors
83	Ventilation unit operating hours						Unit switched on (also applies to standby mode)
13	Air flow in LOW mode	0	100	1	10	m ³ /h	LOW = reduced ventilation
14	Air flow in MEDIUM mode	0	100	1	30	m ³ /h	MEDIUM = normal ventilation
15	Air flow in HIGH mode	0	100	1	50	m ³ /h	HIGH = increased ventilation
44	Air flow for extract air in HIGH I mode	0	100	1	70	m ³ /h	Button 4 on the ventilation unit's membrane keypad
45	Air flow for supply air in HIGH I mode	0	100	1	70	m ³ /h	Button 4 on the ventilation unit's membrane keypad
11	Air flow for intensive ventilation	0	100	1	100	m ³ /h	Button 5 on the ventilation unit's membrane keypad
12	Intensive ventilation duration	0	240	1	15	min	Button 5 on the ventilation unit's membrane keypad
55	Switch-on delay for external control input	0	240	1	1	min	
56	Follow-up time for external control input	0	240	1	15	min	
54	Air flow for extract air/supply air with external control input	0	100	1	60	m ³ /h	
95 ⁽¹⁾	External control input mode	0	18	1	12		Selected ventilation program for external control input
36	Threshold for humidity control	40	80	1	60	%	Threshold for humidity control above which the ventilation unit increases the ventilation level
37	Min. air flow for humidity control	0	100	1	10	m ³ /h	0: control for Standby mode active
38	Max. air flow for humidity control	0	100	1	60	m ³ /h	
39	Threshold for CO ₂ control	400	1400	10 ⁽²⁾	800	ppm	Threshold for CO ₂ control above which the ventilation unit increases the ventilation level



Code	Parameter	Min.	Max.	Increment	Default	Unit	Comment
40	Min. air flow for CO ₂ control	0	100	1	10	m ³ /h	0: control for Standby mode active
41	Max. air flow for CO ₂ control	0	100	1	60	m ³ /h	
16 ⁽¹⁾	Mode for button 1 on the ventilation unit's membrane keypad	0	18	1	0		LOW = reduced ventilation
17 ⁽¹⁾	Mode for button 2 on the ventilation unit's membrane keypad	0	18	1	1		MEDIUM = normal ventilation
18 ⁽¹⁾	Mode for button 3 on the ventilation unit's membrane keypad	0	18	1	2		HIGH = increased ventilation
119 ⁽¹⁾	Mode for button 4 on the ventilation unit's membrane keypad	0	18	1	11		HIGH 1
120 ⁽¹⁾	Mode for button 5 on the ventilation unit's membrane keypad	0	18	1	14		Intensive ventilation
7	Pause time	1	255	1	60	min	Time interval for which the ventilation unit pauses in sniffing mode.
8	Sniffing time	5	255	1	5	min	Time interval for which recording of the relative atmospheric humidity and the CO ₂ concentration takes place
9	Air flow in sniffing mode	10	100	1	20	m ³ /h	Air flow during the recording of the relative atmospheric humidity and the CO ₂ concentration
10	Position of air flaps in Standby mode	0	1	1	1	-	0: air flaps open in Standby mode 1: air flaps closed in Standby mode
42	Air flow for extract air in supply air operation ventilation program	0	100	1	0	m ³ /h	InControl pushbutton sensor and M-WRG-FBH wireless remote control

Code	Parameter	Min.	Max.	Increment	Default	Unit	Comment
43	Air flow for supply air in supply air operation ventilation program	0	100	1	50	m³/h	InControl pushbutton sensor and M-WRG-FBH wireless remote control
46	Air flow for extract air in extract air operation ventilation program	0	100	1	50	m³/h	InControl pushbutton sensor and M-WRG-FBH wireless remote control
47	Air flow for supply air in extract air operation ventilation program	0	100	1	0	m³/h	InControl pushbutton sensor and M-WRG-FBH wireless remote control
196	Cross-ventilation running time	0	1440	1	120	min	
57	Ventilation level for continuous operation	0	100	1	30	m³/h	Ventilation levels for supply air and extract air are set at the same time
50 ⁽³⁾	InControl pushbutton sensor: CO ₂ control or automatic mode	0	1	1	0	-	0: CO ₂ control 1: automatic mode
101 ⁽⁴⁾	External switch mode	0	2	1	1		0 = deactivated 1 = air flow 2 = mode 3 = not used
131	Summer/winter changeover	0	1	1	1		0 = winter 1 = summer
123	Time zone	-720	840	1	60	min	Setting in minutes +/- from UTC, +60 = Germany
96 ⁽⁵⁾	InControl pushbutton sensor standby ON/OFF	0	1	1	1		0 = standby OFF 1 = standby ON
133 ⁽¹⁾	Smoke detector input mode	0	18	1	18		Unit OFF
134	Smoke detector contact type	0	1	1	0		0 = NO contact 1 = NC contact
151	CO ₂ control with 2 sensors	0	1	1	0		0 = Off 1 = On
152 ⁽⁶⁾	Threshold for VOC control	0	4000	1	1500	ppm	Threshold for VOC control above which the ventilation unit increases the ventilation level
153 ⁽⁶⁾	Min. air flow for supply air with 2 sensors	0	100	1	10	m³/h	

Code	Parameter	Min.	Max.	Increment	Default	Unit	Comment
154 ⁽⁶⁾	Delay time with 2 sensors	0	120	1	10	min	
168 ⁽¹⁾	External switch I mode	0	18	1	0		
169 ⁽¹⁾	External switch II mode	0	18	1	1		
170 ⁽¹⁾	External switch III mode	0	18	1	2		
93	Restore factory default settings	0	1	1	0		1 = restore factory default settings

Table 7: Variable parameters in the Device settings menu for ventilation units from the M-WRG-II series

(1) See list of modes in section 9.4.5 on page 40

(2) Hold down the  or  button to scroll through the values faster

(3) For the M-WRG-II P-T-F / M-WRG-II E-T-F and M-WRG-II P-T-FC / M-WRG-II E-T-FC unit types, the wireless remote control can be used to assign the “CO₂” program button on the InControl pushbutton sensor to the “Automatic mode” ventilation program. In this case, the ventilation mode will be regulated in relation to the CO₂ concentration **and** the relative room air humidity.

(4) Code 101 is used to set up buttons 1 to 3 on the 4-way wireless pushbutton switch M-WRG-FT and for the wireless sensors:

Value 1: button 1, 2, 3 = LOW, MEDIUM, HIGH

Value 2: ventilation programs activated for codes 168 to 170

(5) Only needed for the InControl pushbutton sensor

(6) Only needed for the M-WRG-II O/VOC-AUL option

9.4.4 Variable parameters for ventilation units from the M-WRG series

Code	Parameter	Min.	Max.	Increment	Default	Unit	Comment
84	Fan motors operating hours						Running time of the fan motors
83	Ventilation unit operating hours						Unit switched on (also applies to standby mode)
13	Air flow in LOW mode	0	100	10	10	m ³ /h	LOW = reduced ventilation
14	Air flow in MEDIUM mode	0	100	10	30	m ³ /h	MEDIUM = normal ventilation
15	Air flow in HIGH mode	0	100	10	60	m ³ /h	HIGH = increased ventilation
44	This code only applies for ventilation units from the M-WRG-II series						
45	This code only applies for ventilation units from the M-WRG-II series						
11	Air flow for intensive ventilation	0	100	10	100	m ³ /h	
12	Intensive ventilation duration	0	240	1	15	min	

Code	Parameter	Min.	Max.	Increment	Default	Unit	Comment
55	Switch-on delay for external control input	0	240	1	1	min	
56	Follow-up time for external control input	0	240	1	15	min	
54	Air flow for extract air/supply air with external control input	0	100	10	70	m ³ /h	
95 ⁽¹⁾	External control input mode	0	18	1	12		Selected ventilation program for external control input
36	Threshold for humidity control	40	80	1	60	%	Threshold for humidity control above which the ventilation unit increases the ventilation level
37	Min. air flow for humidity control	0	100	10	10	m ³ /h	0: control for Standby mode active
38	Max. air flow for humidity control	0	100	10	60	m ³ /h	
39	Threshold for mixed gas/CO ₂ control	400	1400	1 ⁽²⁾	600	ppm	Threshold for mixed gas/CO ₂ control above which the ventilation unit increases the ventilation level
40	Min. air flow for mixed gas/CO ₂ control	0	100	10	10	m ³ /h	0: control for Standby mode active
41	Max. air flow for mixed gas/CO ₂ control	0	100	10	60	m ³ /h	
16 ⁽¹⁾	Mode for 3-way stepping switch on ventilation unit in position I	0	18	1	0		LOW = reduced ventilation
17 ⁽¹⁾	Mode for 3-way stepping switch on ventilation unit in position II	0	18	1	1		MEDIUM = normal ventilation
18 ⁽¹⁾	Mode for 3-way stepping switch on ventilation unit in position III	0	18	1	2		HIGH = increased ventilation

Code	Parameter	Min.	Max.	Increment	Default	Unit	Comment
119	This code only applies for ventilation units from the M-WRG-II series						
120	This code only applies for ventilation units from the M-WRG-II series						
7	Pause time	1	255	1	60	min	Time interval for which the ventilation unit pauses in sniffing mode.
8	Sniffing time	5	255	1	5	min	Time interval for which recording of the relative atmospheric humidity and the mixed gas/CO ₂ concentration takes place
9	Air flow in sniffing mode	10	100	10	20	m ³ /h	Air flow during the recording of the relative atmospheric humidity and the mixed gas/CO ₂ concentration
10	Position of air flaps in Standby mode	0	1	1	1	-	0: air flaps open in Standby mode 1: air flaps closed in Standby mode
42	Air flow for extract air in supply air operation ventilation program	0	100	10	15	m ³ /h	InControl pushbutton sensor and M-WRG-FBH wireless remote control
43	Air flow for supply air in supply air operation ventilation program	0	100	10	50	m ³ /h	InControl pushbutton sensor and M-WRG-FBH wireless remote control
46	Air flow for extract air in extract air operation ventilation program	0	100	10	50	m ³ /h	InControl pushbutton sensor and M-WRG-FBH wireless remote control
47	Air flow for supply air in extract air operation ventilation program	0	100	10	15	m ³ /h	InControl pushbutton sensor and M-WRG-FBH wireless remote control
196	This code only applies for ventilation units from the M-WRG-II series						
57	Ventilation level for continuous operation	0	100	10	30	m ³ /h	Ventilation levels for supply air and extract air are set at the same time
50 ⁽³⁾	InControl pushbutton sensor: mixed gas/CO ₂ control or automatic mode	0	1	1	0	-	0: mixed gas/CO ₂ control 1: automatic mode

Code	Parameter	Min.	Max.	Increment	Default	Unit	Comment
101 ⁽⁴⁾	External switch mode	0	3	1	1		0 = deactivated 1 = air flow 2 = mode 3 = not used
131	This code only applies for ventilation units from the M-WRG-II series						
123	This code only applies for ventilation units from the M-WRG-II series						
96 ⁽⁵⁾	InControl push-button sensor standby ON/OFF	0	1	1	1		0 = standby OFF 1 = standby ON
133	This code only applies for ventilation units from the M-WRG-II series						
134	This code only applies for ventilation units from the M-WRG-II series						
151	This code only applies for ventilation units from the M-WRG-II series						
152	This code only applies for ventilation units from the M-WRG-II series						
153	This code only applies for ventilation units from the M-WRG-II series						
154	This code only applies for ventilation units from the M-WRG-II series						
168	This code only applies for ventilation units from the M-WRG-II series						
169	This code only applies for ventilation units from the M-WRG-II series						
170	This code only applies for ventilation units from the M-WRG-II series						
93	Restore factory default settings	0	1	1	0		1 = restore factory default settings

Table 8: Variable parameters in the Device settings menu for ventilation units from the M-WRG series

(1) See list of modes in section 9.4.5 on page 40

(2) Hold down the  or  button to scroll through the values faster

(3) For the M-WRG-S/Z-T-FC and M-WRG-S/Z-KNX-FC unit types, the wireless remote control can be used to assign the “CO₂” program button on the InControl pushbutton sensor to the “Automatic mode” ventilation program. In this case, the ventilation mode will be regulated in relation to the mixed gas/CO₂ concentration **and** the relative room air humidity.

(4) Code 101 is used to set up buttons 1 to 3 on the 4-way wireless pushbutton switch M-WRG-FT and for the wireless sensors:
Value 1: button 1, 2, 3 = LOW, MEDIUM, HIGH

(5) Only needed for the InControl pushbutton sensor

9.4.5 List of modes for ventilation units from the M-WRG-II and M-WRG series

Mode	M-WRG-II	M-WRG
0	LOW	LOW
1	MEDIUM	MEDIUM
2	HIGH	HIGH
3	Humidity control	Humidity control
4	CO ₂ control	Mixed gas/CO ₂ control
5	Automatic mode	Automatic mode

Mode	M-WRG-II	M-WRG
6	Not used	Not used
7	Supply air operation	Supply air operation
8	Not used	Not used
9	Not used	Not used
10	Extract air operation	Extract air operation
11	HIGH 1	Not used
12	Ventilation level for external control input	Ventilation level for external control input
13	Not used	Not used
14	Intensive ventilation	Intensive ventilation
15	Not used	Not used
16	Not used	Not used
17	Not used	Not used
18	Unit OFF	Unit OFF

Table 9: List of modes for ventilation units from the M-WRG-II and M-WRG series

10 Special functions

10.1 Standby mode

10.1.1 Set ventilation unit to Standby mode

- ▶ Hold down the  button on the wireless remote control for more than 3 seconds to switch from Ventilation mode to Standby mode.

This triggers the following actions:

- The current ventilation mode is ended. The ventilation levels for supply air and extract air are set to 0 (see Fig. 29).
- The ventilation unit continues to be supplied with power.
- The air flaps close (default setting).

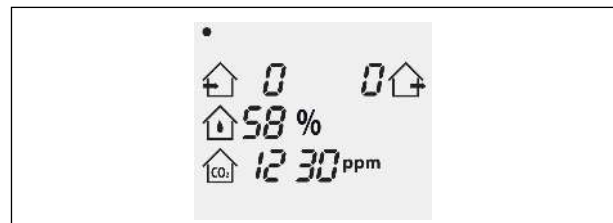



Fig. 29: Ventilation unit in Standby mode

NOTICE

It is not a good idea to leave the ventilation unit in Standby mode for long periods (see also "Rules for correct usage" in the operating instructions supplied with your ventilation unit).

10.1.2 Exit standby mode

- ▶ Press the  button to switch to the menu for selecting the ventilation programs (see section 9.1 on page 27).
- ▶ Select the desired ventilation program or wait until the ventilation unit starts in the default “Continuous operation” ventilation program.

10.2 Activate or deactivate intensive ventilation

- ▶ Hold down the  button for more than 3 seconds to activate or deactivate the intensive ventilation (see section 8.1.7 on page 23 or 8.2.7 on page 26).

10.3 Reset filter change indicator

- ▶ Hold down the  button for more than 3 seconds to reset the filter change indicator. You will find more details on filter maintenance in the operating instructions for your ventilation unit.

11 Operation with multiple ventilation units

Up to six ventilation units can be controlled with one M-WRG-FBH wireless remote control.

- The ventilation units must all be of the same type.
- The number of connected ventilation units corresponds to the number of dots that appear in the top left corner of the LCD display.
- The wireless remote control automatically communicates with the ventilation unit with which it has the best wireless connection. This is not necessarily the ventilation unit that is closest to the wireless remote control.
- The dot corresponding to the ventilation unit with which communication is currently active flashes on the LCD display. This unit also supplies values for relative humidity and mixed gas/CO₂ concentration.
- If there are multiple ventilation units of the same type connected to one M-WRG-FBH wireless remote control, the same ventilation program is activated for all the ventilation units.
- If multiple ventilation units of the same type with humidity and/or mixed gas/CO₂ control are controlled by one M-WRG-FBH wireless remote control, each ventilation unit regulates the air exchange on the basis of its own measured values.

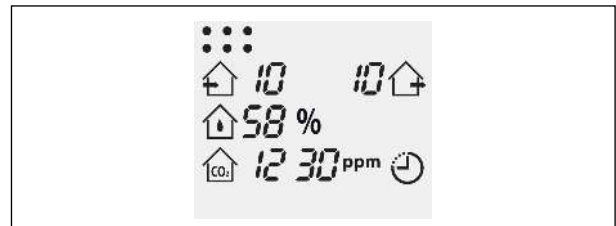





Fig. 30: Six ventilation units connected

12 Troubleshooting

Error	Cause	Remedy
The ! symbol is displayed on the wireless remote control.	Fault in the ventilation unit (e.g. faulty sensor or motor)	Have the ventilation unit repaired by Meltem or by an authorised specialist company
The ! and  symbols are displayed on the wireless remote control.	No wireless connection to the ventilation unit	<ul style="list-style-type: none"> — Reduce the distance between the wireless remote control and ventilation unit — Switch on the ventilation unit
The  symbol is displayed on the wireless remote control.	Low battery charge	Replace the batteries in the wireless remote control (see section 6.1 on page 14)
For ventilation units from the M-WRG series only: The F symbol flashes at 2-second intervals on the wireless remote control.	Air filter is dirty	Change air filter (see ventilation unit operating instructions)
The F symbol is displayed continuously on the wireless remote control.	One-year filter change interval exceeded	Change air filter (see ventilation unit operating instructions)
The  symbol is displayed on the wireless remote control.	Frost protection active	-
Connection between wireless remote control and ventilation unit cannot be established or disconnected.	When the ventilation unit is switched on, it remains in connection mode for 5 minutes. This time interval was exceeded.	Switch the ventilation unit off and on again



We have checked the content of this publication for conformity with the unit described in it. There may nevertheless still be differences, so we cannot guarantee complete accuracy.

The information in this publication is regularly checked and any necessary corrections are made in subsequent editions.

Copyright © Meltem Wärmerückgewinnung GmbH & Co. KG

We reserve the right to make changes.

Meltem Wärmerückgewinnung GmbH & Co. KG

Am Hartholz 4

D-82239 Alling

Germany

Tel. +49 8141 40 41 79-0

Fax +49 8141 40 41 79-9

Internet: www.meltem.com

Email: info@meltem.com



Go to
Meltem download area